



EAS[®]

*Mechanical
Torque
Limiters*

www.mayr.de

K.407.01.GB

mayr[®]
power-
transmission

Why do you use torque limiting clutches ?

The idea:

EAS[®]-clutches help prevent damage to persons, machinery and equipment, making machines safer and more reliable.

Repairs and downtimes are minimised. Availability and productivity are therefore increased. A torque limiting clutch is a mechanical device which disengages immediately in case of an overload and disconnects input and output. Additionally an electrical signal can be provided through mechanical actuation of a limit switch to switch off the complete equipment. This happens when the pre-set torque is exceeded. Such types of clutches guarantee an efficient protection against overload damages.

Torque limiting clutches offer decisive advantages in comparison to other systems:

- Motor overcurrent relays give only a signal in case of an overload. This can be used to switch off the drive. Time passes in which the rotational energy could cause further damage until the equipment is stopped. By using overload clutches this will be avoided due to an immediate disconnection of input and output drive components.
- That safety device, the good old shear pin has the disadvantage that costly and circumstantial repairs after an overload are necessary. This causes long downtimes. Overload clutches re-engage immediately after an incident.

EAS[®]-clutches increase productivity and prevent damage to machinery and equipment.

Why do you use EAS[®]-clutches ?

Our long experience in the field of overload safety devices and continuous development and improvement of these products enable us to offer you the best torque limiting clutch for every application. Modern series production and careful inspection guarantee the constant high quality of our products.

EAS[®]-safety clutches offer considerable advantages for your application:



- The EAS[®]-safety clutch is a precise and economic torque limiter. Even under extreme conditions a high and constant disengaging torque is provided ($\pm 5\%$).
- It offers a wide torque range due to a versatility of spring configurations. Even with large shaft diameters, low torques are possible.
- Low mass moment of inertia.
- The torque can easily be set due to an adjusting table and graduations on the clutch. The setting is kept accurately by the positive locking of an adjusting nut.
- The EAS[®]-safety clutch offers a constant and precise torque transmission due to the guaranteed quality of the single components.
- The constructive design (balls or rollers transmit the torque via surface pressure or line contact) effects a long service life and does not need any maintenance.
- The switching element with its typical EAS[®]-groove allows the usage of standard limit switches. The drive can be switched off immediately by the signal from the limit switch.

Installation of the EAS[®]-torque limiting clutch:

It is advantageous to fit the EAS[®]-torque limiting clutch as close as possible to the trouble spot or directly to the drive components which require protection.

The larger the mass moment of inertia of the drive components which are uncoupled due to the disengagement of the clutch, the smaller are the damaging forces in case of a collision.

Tests have proved that it is possible to disconnect up to 90% of the damaging energy by using EAS[®]-torque limiting clutches.

Recommended positions for the EAS[®]-torque limiting clutch:

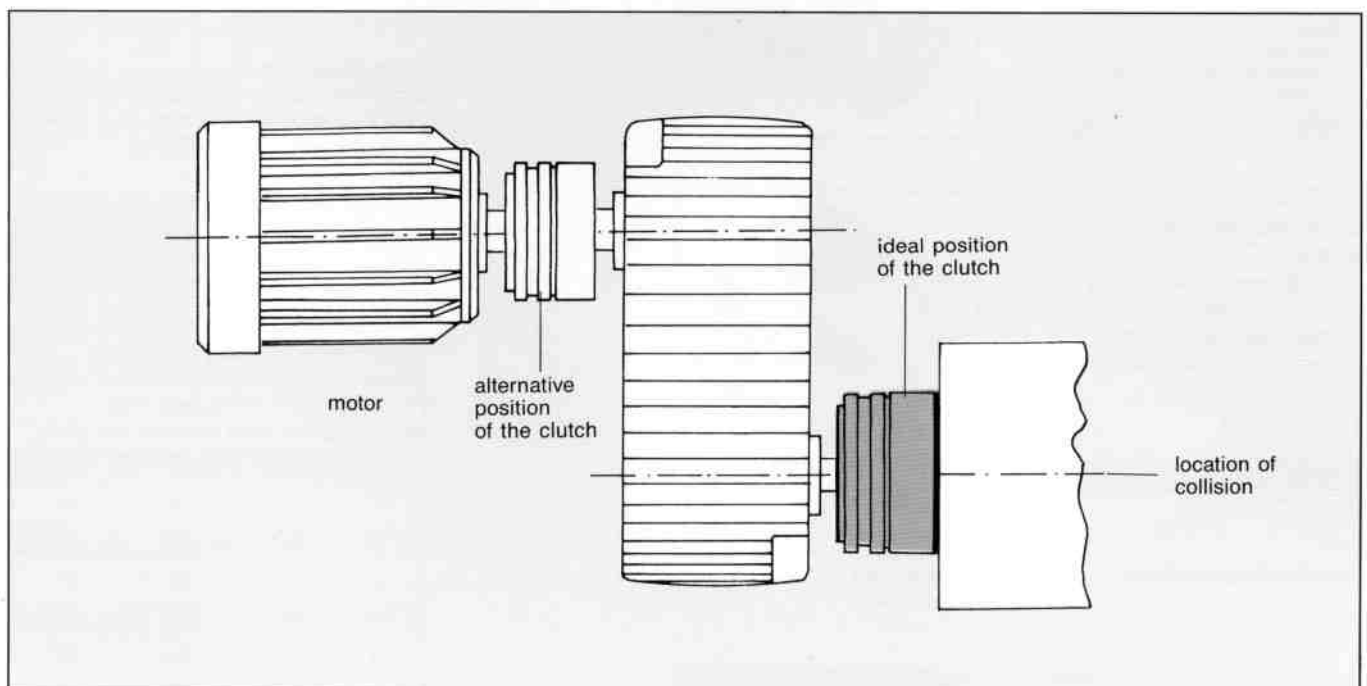
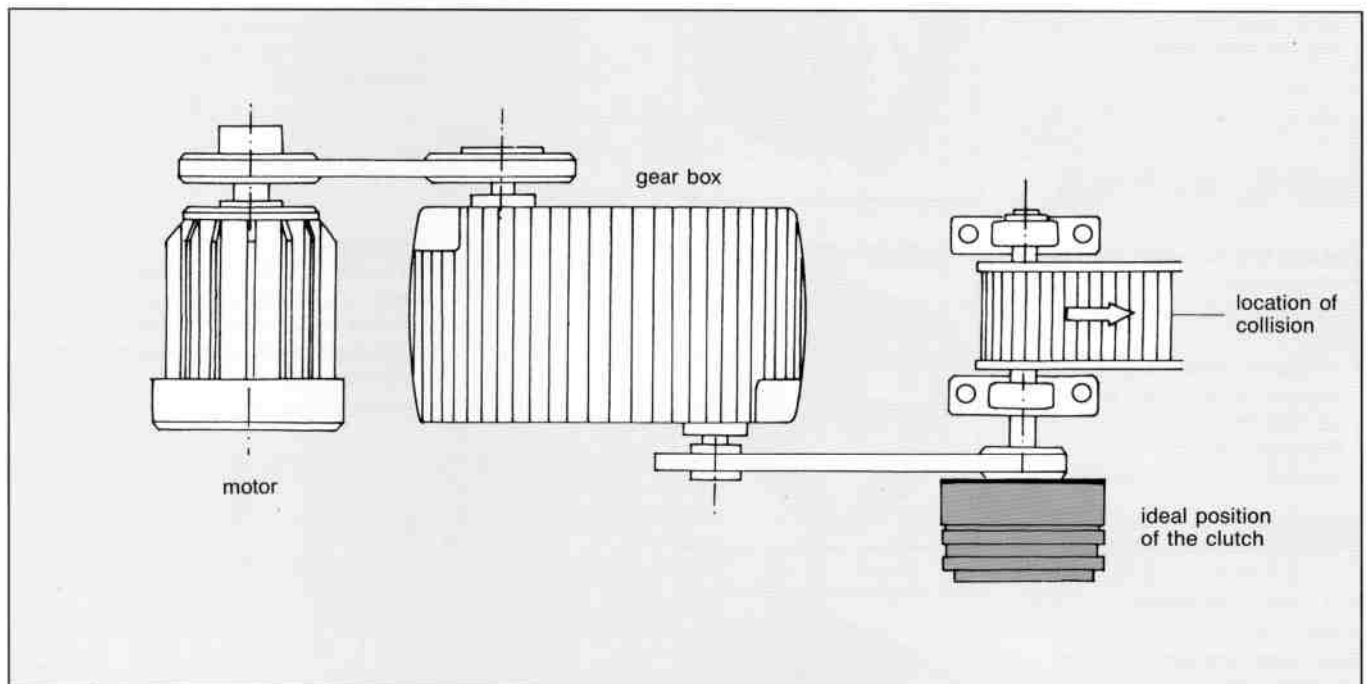

The operation ready torque limiting clutch

EAS[®]-standard ratchetting clutch

- * Uniformly constant torque transmission.
- * Reliable protection in case of an overload.
- * Immediately ready for operation.

Page 6

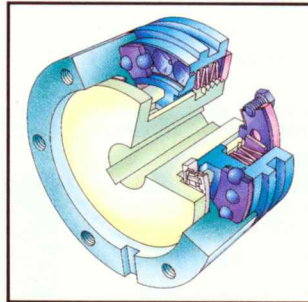

Torque transmission

positive

- * from hub to control element due to spline profile,
- * by transmission elements (balls or rollers) via pressure flange to the drive element, e.g. gear wheel, pulley.

The single position clutch keeps accurate time.

EAS[®]-standard synchronous clutch

- * Re-engagement only at angular increments.

Page 18

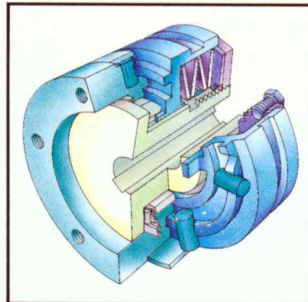

Disengagement accuracy

- * Adjustable torques are transmitted via balls or rollers in geometrical defined seats from control element to pressure flange.
- * In case of an overload the transmission elements (precision balls or rollers) disengage.

The load disconnecting torque limiting clutch

EAS[®]-standard overload clutch

- * In case of an overload positive disconnection of input and output components.
- * Disconnected rotating masses free to slow down.

Page 30

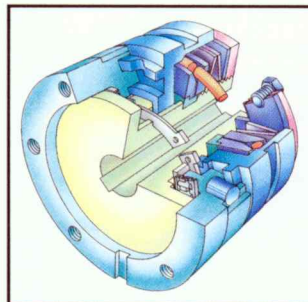

Service life

High-quality materials, hardened functional components and manufacturing precision guarantee excellent repetitive accuracy of the set disengaging torque and provide a long service life. Functional safety for the whole service life.

The load disconnecting accurate torque limiter

EAS[®]-standard synchronous/overload clutch

- * In case of an overload positive disconnection of input and output components.
- * Disconnected rotating masses free to slow down.
- * Re-engagement only at angular increments.

Page 36

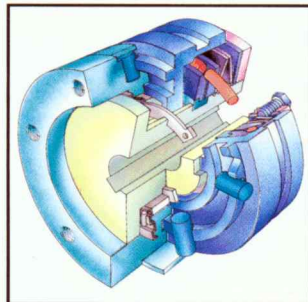

Flange drive keyway

For positive connection between pressure flange and drive element e.g. gear, chain sprocket, toothed belt pulley etc.

The load holding safety clutch

EAS[®]-standard torque sensor

- * No disconnection of input and output components when overload occurs.
- * Load security is guaranteed

Page 42

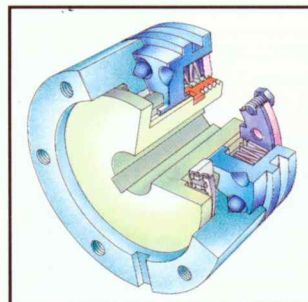

Pressure flange

- * Axial loads via needle bearing.
- * Radial loads by bearing bushing.
- * Precisely true running and axial location of the drive element e.g. gear.
- * Additional radial / axial bearings are possible.

Technical explanations

Page 52

Accessories

Limit switch,

Page 58

EAS[®]-standard torque limiting clutch

Torque security

against self acting, unintended adjustment of the pre-set limiting torque by

- * positive screw connection of the lock washer with locking screw

Torque adjustment

- * Precise adjustable torque limiting.
- * By means of an adjusting nut with fine-pitch thread and graduation. Mayr-cup springs with their special characteristics are pre-stressed sensitively and exactly against the control element.
- * The EAS[®]-safety clutch, therefore, protects against overload of machines and equipment.

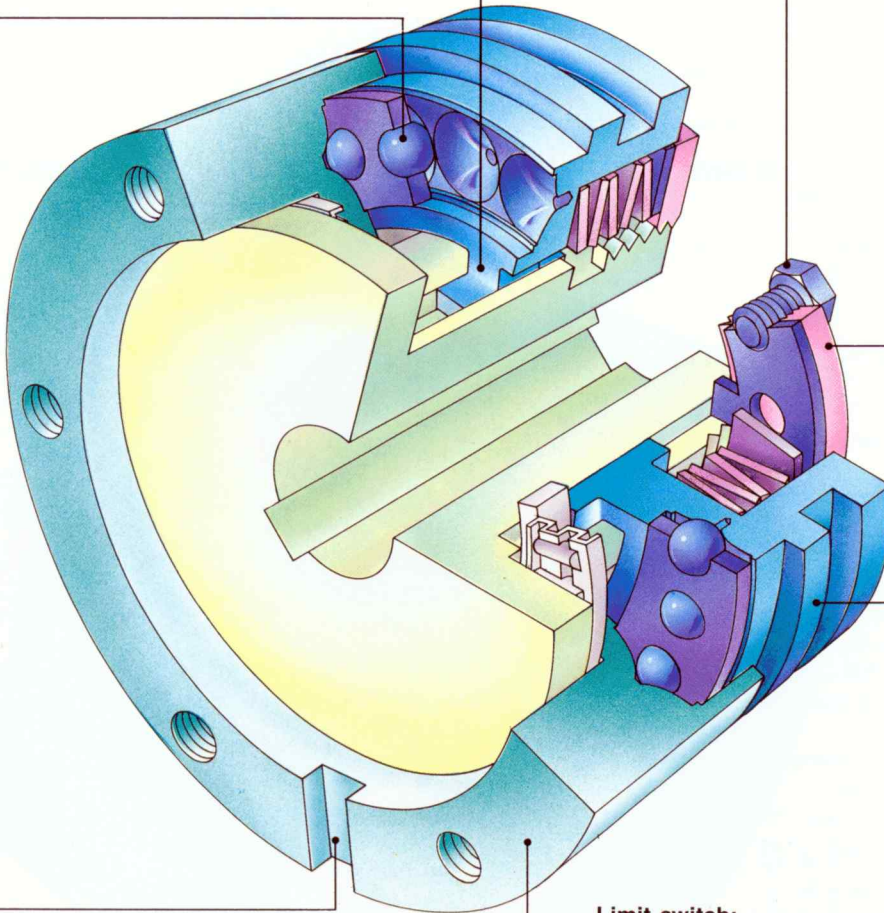

Control element:

- * The control element moves axially in case of an overload,
- * This operates the limit switch.

Limit switch:

- * Mechanical or contactless
- * Extreme short switch off times
- * Simple switch point adjustment

Signal usage:

- * In case of an overload the limit switch quickly and precisely detects the axial disengagement movement of the control element.
- * The limit switch gives a signal to switch off the drive or for another control function.

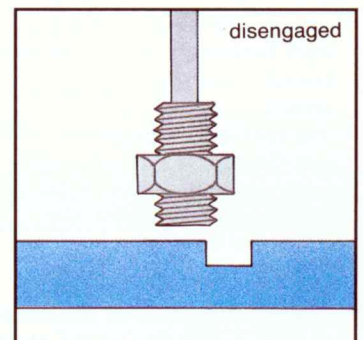
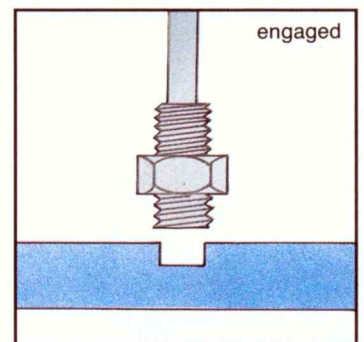

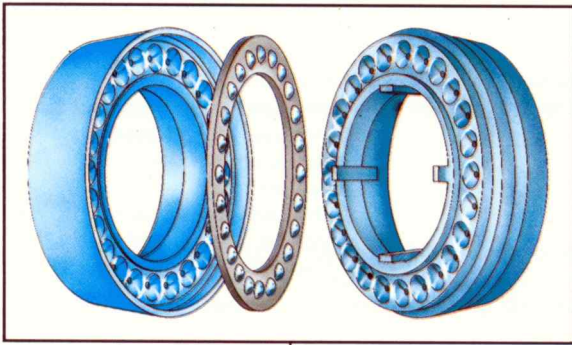

Operating principle of the EAS[®]-ratchetting clutch

- * The clutch ratchets when the pre-set limiting torque is achieved.
- * The EAS[®]-ratchetting clutch engages automatically at the pre-set convenient ball detent.
- * The Mayr-limit switch transmits a signal to switch off the drive or for any other control function.

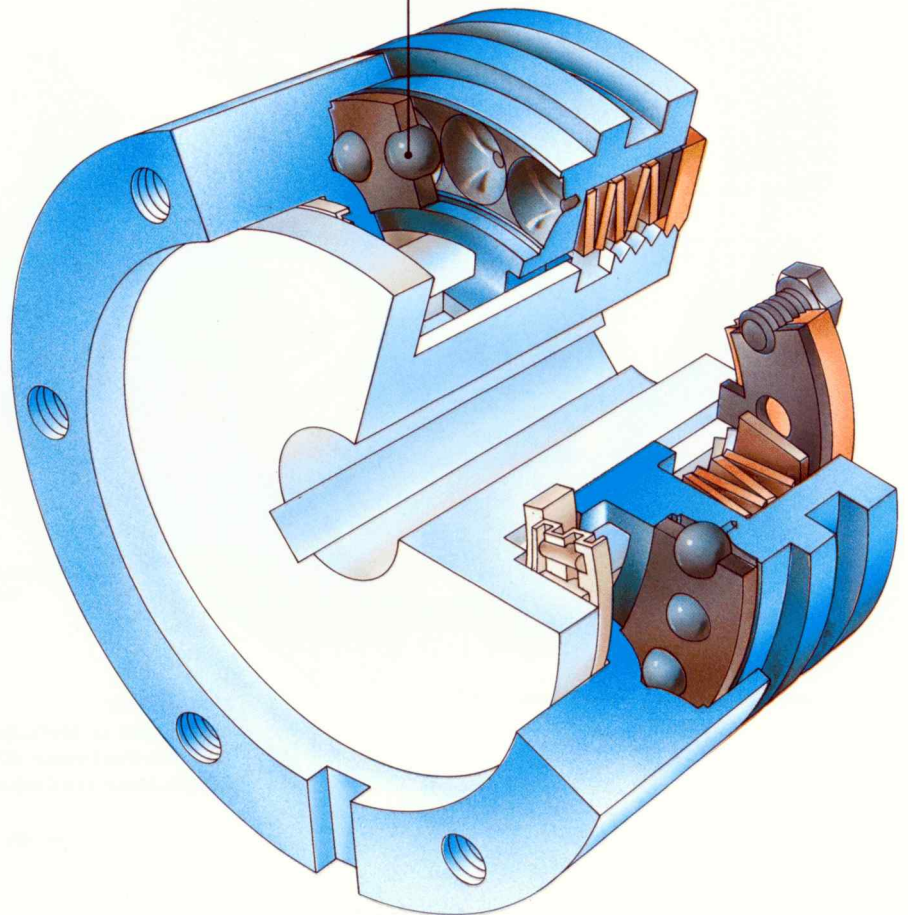
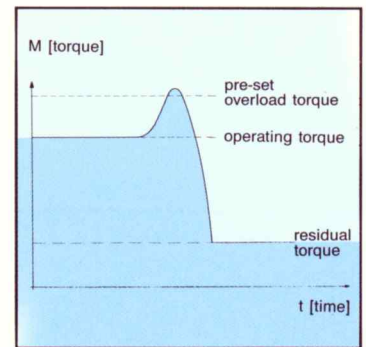

The safety clutch – immediately ready for operation

- * Uniform and constant disengagement behaviour due to an extreme precise manufacture of the ball detents.
- * The EAS[®]-ratchetting clutch guarantees a prompt automatic readiness for operation of the machine and equipment after removal of the overload at the drive.

Therefore reduction of downtimes and long availability of the machine or equipment, therefore high productivity!

Summary of types

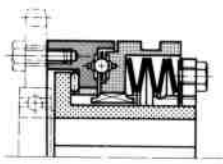
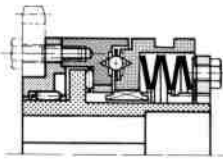
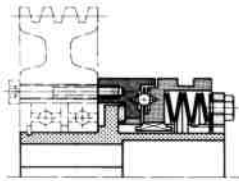
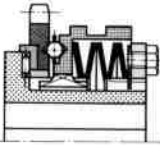
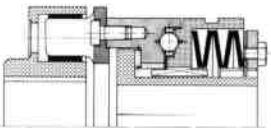
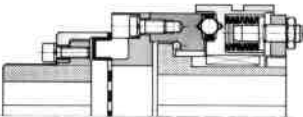
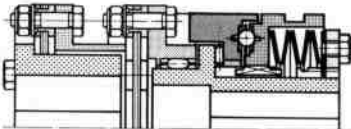
EAS [®] -clutch	Type	Torque (Nm)	Application
EAS[®]-flanged version 	400_00.0	2,5÷6000	For fitting drive elements such as chain sprockets, gears, toothed belt pulleys, V-belt pulleys, etc. The drive element and bearing are customer supply. page 8
EAS[®]-short supported hub 	400_00.5	2,5÷6000	EAS [®] -clutch with fitted bearing to take single, symmetrical and narrow drive elements (chain sprocket, gear, single-groove V-belt pulley, etc.). Provision of an additional bearing for the drive element by the customer becomes unnecessary. Clutch, which can easily be pushed on. page 10
EAS[®]-long projecting hub 	400_00.1	2,5÷6000	The bearing of the drive element can be carried out by the customer to suit his own application. Suitable for wide, projecting drive elements; ball bearing or bronze bushing possible. Compact design – very advantageous also for short shaft ends. page 12
EAS[®]-sproc 	410_00.0	2,5÷700	EAS [®] -clutch with built-in chain sprocket, as a reasonably priced drive element. By fitting the chain sprocket to the overload clutch, an additional bearing for the chain sprocket becomes unnecessary. page 14
EAS[®]-lastic 	437_00.0	2,5÷700	Torsionally flexible overload clutch for connecting two shafts. The flexible coupling element is designed as a simple push-on coupling, permitting easy fitting and removal of the clutch. page 15
EAS[®]-positive 	435_00.0	150÷6000	Positive, torsionally flexible overload clutch for connecting two shafts. The flexible coupling section is designed as a torsionally flexible, resilient slip-on coupling. The coupling has axial, radial, angular and torsional resiliences. page 16
EAS-torsionally rigid 	436_00.8	2,5÷700	Torsionally rigid overload clutch for connecting two shafts. Flexible coupling section designed as a torsionally rigid, all-steel coupling. The coupling can absorb angular, radial and axial misalignments; the coupling is torsionally rigid in the direction of rotation. page 17
Electronic accessories			Limit switch pages 58 to 60

Flanged version

Type 400._00.0

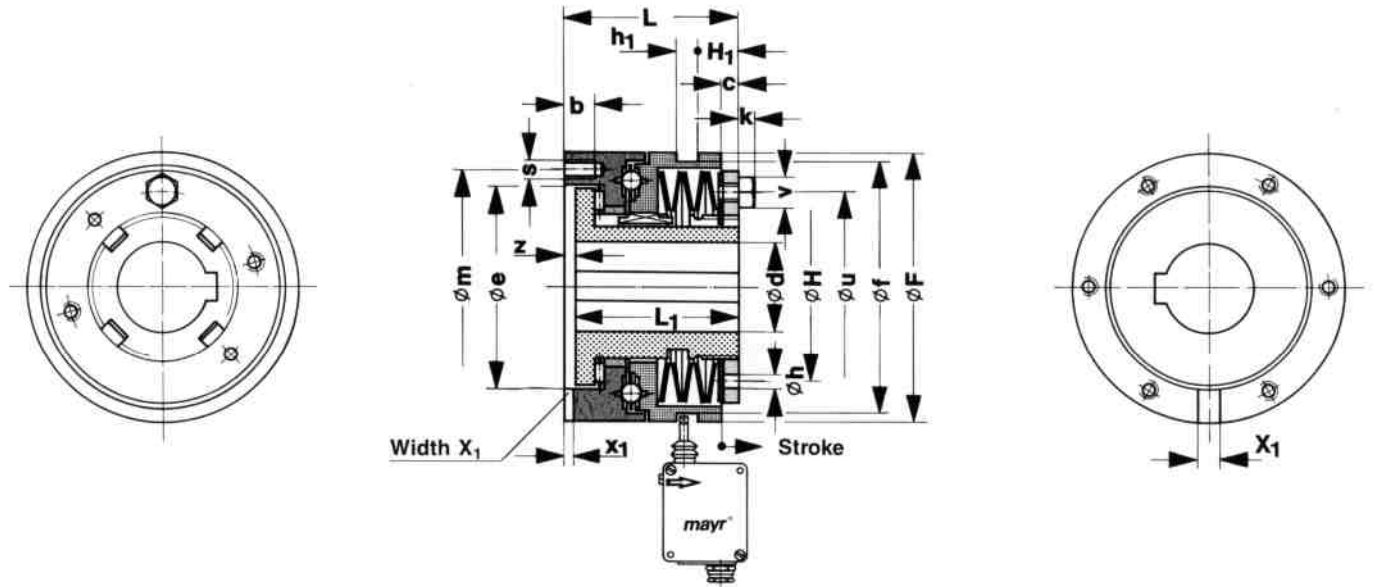

sizes 0-5 Type 400._00.0

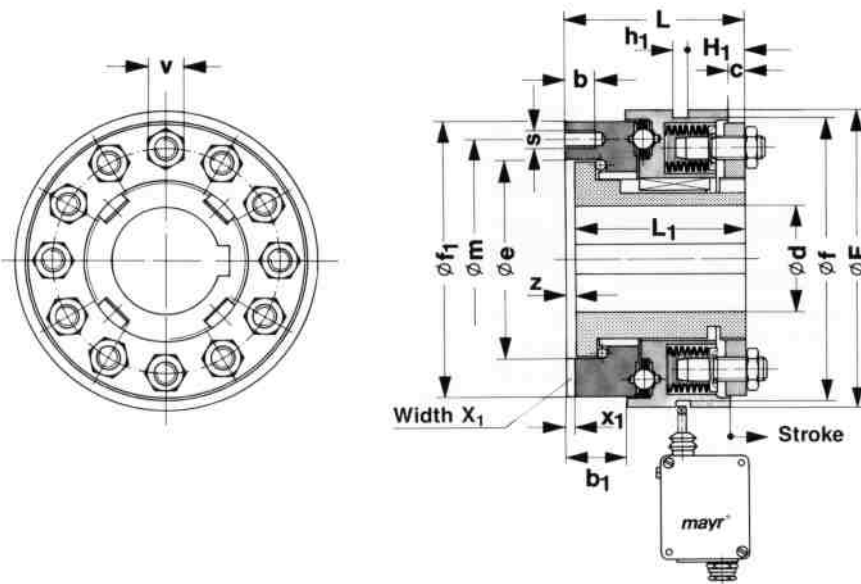

sizes 6-9 Type 400._00.0

Technical data

size	Limiting torques for overload M_G			Max. speeds		Weight pilot bored kg	Stroke of the control element in the event of an overload mm	Mass moments of inertia	
	Type 400.400.0 Nm	Type 400.500.0 Nm	Type 400.600.0 Nm	Type 400.400.0 400.500.0 rpm	Type 400.600.0 rpm			Pressure flange side kgm ²	Hub side kgm ²
0	2,5 – 5	5 – 10	10 – 20	4300	2150	0,5	1,4	0,00009	0,00010
1	6 – 12	12 – 25	25 – 50	2880	1440	1,5	2,3	0,00062	0,00067
2	12 – 25	25 – 50	50 – 100	2360	1180	2,7	2,6	0,00149	0,00190
3	25 – 50	50 – 100	100 – 200	2000	1000	4,7	2,6	0,00380	0,00517
4	50 – 100	100 – 200	200 – 400	1660	830	9,8	3,7	0,00998	0,01631
5	87 – 175	175 – 350	350 – 700	1360	680	16	4,6	0,02345	0,04162
6	150 – 300	300 – 600	600 – 1200	1200	600	21	5	0,03961	0,07689
7	250 – 500	500 – 1000	1000 – 2000	960	480	37	6	0,09693	0,19679
8	425 – 850	850 – 1700	1700 – 3400	840	420	63	7	0,23582	0,50111
9	750 – 1500	1500 – 3000	3000 – 6000	600	300	126	8	0,83119	1,85006

Table of dimensions

size	b	b ₁	c	d _{min}	d _{max}	e	F	f	f ₁	H	H ₁	h
0	6,5	–	5,5	8	20 ¹⁾	41	55	50	–	37	8	3
1	8	–	7	11	25 ²⁾	60	82	72	–	50	12	5
2	10	–	7	15	35	78	100	90	–	67	14	6
3	12	–	10	19	45	90,5	120	112	–	84	21	6
4	16	–	11	25	55	105	146	140	–	104	27	7
5	17	–	12	30	65	120,5	176	170	–	125	33	8
6	19	40	11	40	75	136	200	190	186	–	38	–
7	22	43	15	50	100	168	240	230	227	–	46	–
8	26	52	18	60	120	198	285	275	266	–	53	–
9	36	59	21	70	150	265	380	370	358	–	75	–

size	h ₁	k	L	L ₁	m	s	u	v	X ₁ ^{P9}	x ₁	z
0	9	– ³⁾	38,5	34,5	48	6xM5	37	2 ³⁾	6	3,1	4
1	9	1,3 ³⁾	52	48	70	6xM5	50	3 ³⁾	6	3,1	4
2	9	3,0	61	56	89	6xM6	67	10	8	3,6	5
3	9	5,5	78	73	105	6xM8	84	13	10	4,1	5
4	9	5,5	99,5	93	125	6xM10	97	13	12	4,1	6,5
5	9	5,5	113,5	107	155	6xM12	109	13	14	4,6	6,5
6	9	16	119	112	160	6xM12	–	24	16	5,1	7
7	9	15	141	133	200	6xM16	–	30	18	5,6	8
8	9	12	172	164	230	6xM20	–	30	20	6,1	8
9	9	14,5	190	180	315	6xM24	–	36	20	6,1	10

- 1) above ∅ 16 keyway to DIN 6885/3
- 2) above ∅ 22 keyway to DIN 6885/3
- 3) hexagon socket countersunk head cap screw to DIN 7991

We reserve the right to make dimensional and design alterations

Order example:

To be included when ordering, please state:	size	Type	bore ∅ d ^{H7}	keyway to DIN	with limit switch
Order number:		400._00.0			see page 58

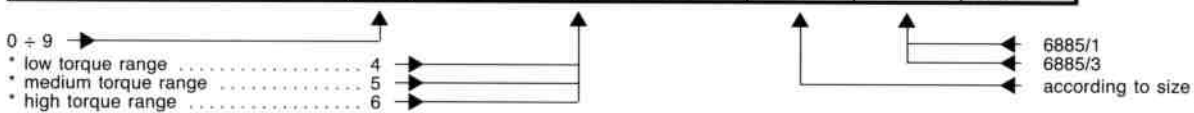

* see technical data, limiting torque for overload M_G

Example: Order number 1 / 400.500.0 / 20 / 6885-1 plus limit switch 055.000.5

Short supported hub

Type 400._00.5

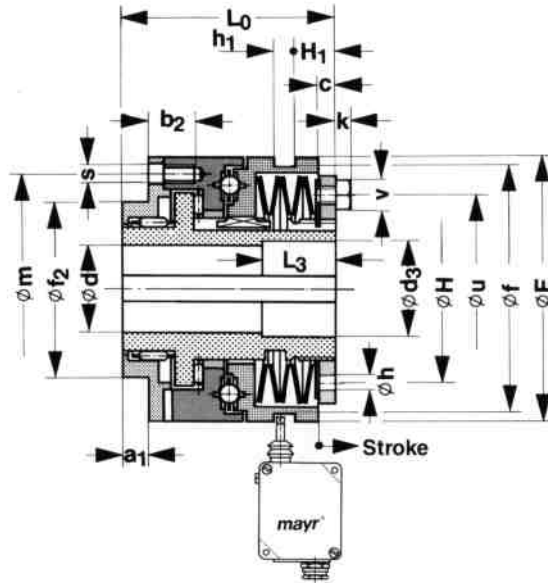

sizes 0-5 Type 400._00.5

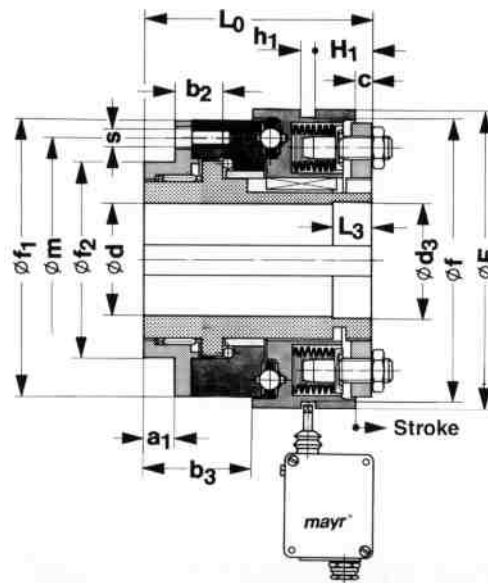

sizes 6-9 Type 400._00.5

Technical data

size	Limiting torques for overload M_G			Max. speeds		Weight pilot bored kg	Stroke of the control element in the event of an overload mm	Mass moments of inertia	
	Type 400.400.5 Nm	Type 400.500.5 Nm	Type 400.600.5 Nm	Type 400.400.5 400.500.5 rpm	Type 400.600.5 rpm			Pressure flange side kgm ²	Hub side kgm ²
0	2,5 – 5	5 – 10	10 – 20	4300	2150	0,7	1,4	0,00012	0,00011
1	6 – 12	12 – 25	25 – 50	2880	1440	2	2,3	0,00091	0,00070
2	12 – 25	25 – 50	50 – 100	2360	1180	3	2,6	0,00182	0,00205
3	25 – 50	50 – 100	100 – 200	2000	1000	6	2,6	0,00484	0,00541
4	50 – 100	100 – 200	200 – 400	1660	830	12	3,7	0,01429	0,01711
5	87 – 175	175 – 350	350 – 700	1360	680	20	4,6	0,03095	0,04281
6	150 – 300	300 – 600	600 – 1200	1200	600	26	5	0,05466	0,07886
7	250 – 500	500 – 1000	1000 – 2000	960	480	44	6	0,12383	0,20268
8	425 – 850	850 – 1700	1700 – 3400	840	420	78	7	0,33589	0,51380
9	750 – 1500	1500 – 3000	3000 – 6000	600	300	155	8	1,14815	1,91707

Table of dimensions

size	a ₁	b ₂	b ₃	c	d _{min}	d _{max}	d ₃	F	f	f ₁	f ₂ h6
0	8	11	–	5,5	8	20 ¹⁾	21	55	50	–	38
1	10	16	–	7	11	25 ²⁾	26	82	72	–	50
2	12	15	–	7	15	35	36	100	90	–	60
3	12	18	–	10	19	45	46	120	112	–	80
4	16	23,5	–	11	25	55	56	146	140	–	100
5	18	25,5	–	12	30	65	66	176	170	–	120
6	20	30	71	11	40	75	76	200	190	186	130
7	25	31	77	15	50	100	101	240	230	227	160
8	30	44	100	18	52	120	121	285	275	266	190
9	32	54	109	21	70	150	151	380	370	358	250

size	H	H ₁	h	h ₁	k	L ₀	L ₃	m	s	u	v
0	37	8	3	9	– ³⁾	51	15	48	6 × M5	37	2 ³⁾
1	50	12	5	9	1,3 ³⁾	70	20	70	6 × M5	50	3 ³⁾
2	67	14	6	9	3,0	78	25	89	6 × M6	67	10
3	84	21	6	9	5,5	96	30	105	6 × M8	84	13
4	104	27	7	9	5,5	124	30	125	6 × M10	97	13
5	125	33	8	9	5,5	140	30	155	6 × M12	109	13
6	–	38	–	9	–	150	25	160	6 × M12	–	–
7	–	46	–	9	–	175	35	200	6 × M16	–	–
8	–	53	–	9	–	220	40	230	6 × M20	–	–
9	–	75	–	9	–	240	40	315	6 × M24	–	–

1) above ∅ 16 keyway to DIN 6885/3

2) above ∅ 22 keyway to DIN 6885/3

3) hexagon socket countersunk head cap screw to DIN 7991

We reserve the right to make dimensional and design alterations.

Order example:

To be included when ordering, please state:	size	Type	bore ∅ d ^{H7}	keyway to DIN	with limit switch
Order number:		400. _ 00.5			see page 58

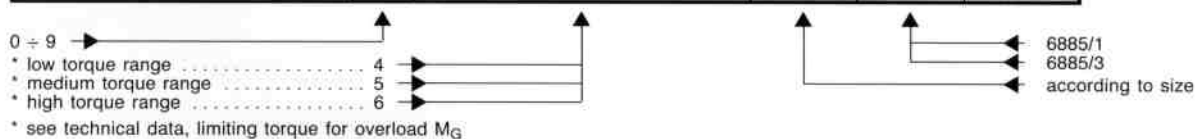

Example: Order number 2 / 400.400.5 / 25 / 6885-1 plus limit switch 055.000.5

Long projecting hub

Type 400._00.1

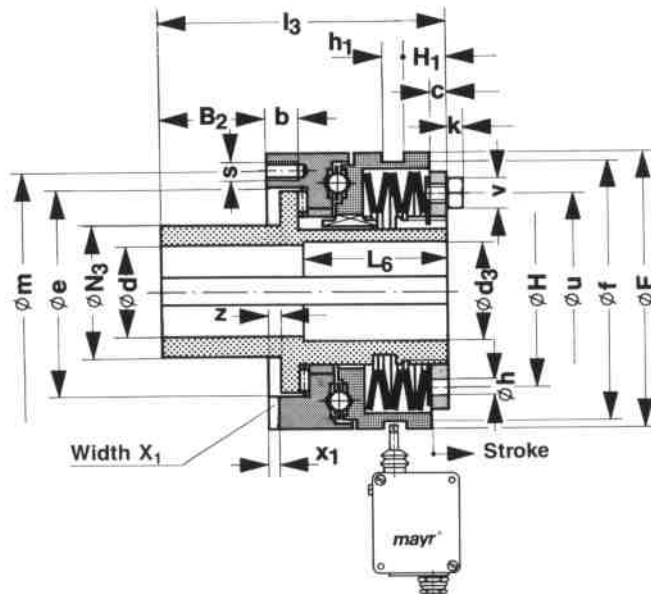

sizes 0-5 Type 400._00.1

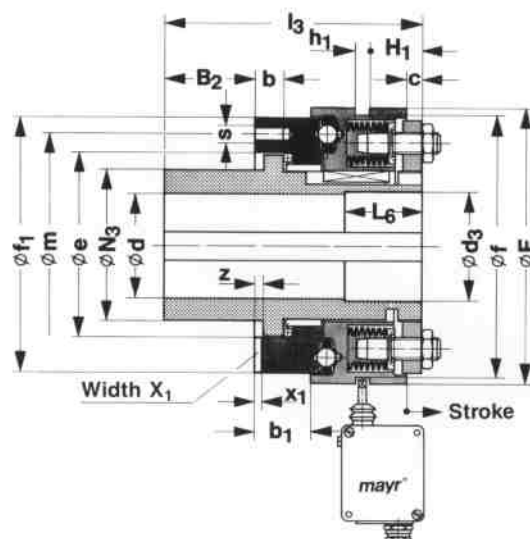

sizes 6-9 Type 400._00.1

Technical data

size	Limiting torques for overload M_G			Max. speeds		Weight pilot bored kg	Stroke of the control element in the event of an overload mm	Mass moments of inertia	
	Type 400.400.1	Type 400.500.1	Type 400.600.1	Type 400.400.1 400.500.1 rpm	Type 400.600.1 rpm			Pressure flange side kgm ²	Hub side kgm ²
	Nm	Nm	Nm						
0	2,5 – 5	5 – 10	10 – 20	4300	2150	0,65	1,4	0,00009	0,00011
1	6 – 12	12 – 25	25 – 50	2880	1440	1,8	2,3	0,00062	0,00072
2	12 – 25	25 – 50	50 – 100	2360	1180	3,4	2,6	0,00144	0,00214
3	25 – 50	50 – 100	100 – 200	2000	1000	6	2,6	0,00381	0,00570
4	50 – 100	100 – 200	200 – 400	1660	830	12	3,7	0,00998	0,01769
5	87 – 175	175 – 350	350 – 700	1360	680	19	4,6	0,02345	0,04393
6	150 – 300	300 – 600	600 – 1200	1200	600	25,5	5	0,03961	0,08253
7	250 – 500	500 – 1000	1000 – 2000	960	480	45	6	0,09693	0,21088
8	425 – 850	850 – 1700	1700 – 3400	840	420	75,5	7	0,23582	0,53181
9	750 – 1500	1500 – 3000	3000 – 6000	600	300	158	8	0,83119	2,02663

Table of dimensions

size	B ₂	b	b ₁	c	d _{min}	d _{max}	d ₃	e	F	f	f ₁	H	H ₁
0	27,5	6,5	–	5,5	8	20 ¹⁾	21	41	55	50	–	37	8
1	33	8	–	7	11	25 ²⁾	26	60	82	72	–	50	12
2	39	10	–	7	15	35	36	78	100	90	–	67	14
3	47	12	–	10	19	45	46	90,5	120	112	–	84	21
4	52,5	16	–	11	25	55	56	105	146	140	–	104	27
5	57,5	17	–	12	30	65	66	120,5	176	170	–	125	33
6	64	19	40	11	40	75	76	136	200	190	186	–	38
7	72	22	43	15	50	100	101	168	240	230	227	–	46
8	82	26	52	18	52	120	121	198	285	275	266	–	53
9	102	36	59	21	70	150	151	265	380	370	358	–	75

size	h	h ₁	k	L ₆	l ₃	m	N ₃ r7	s	u	v	X ₁ ^{P9}	x ₁	z
0	3	9	– ³⁾	25	66	48	28	6 × M5	37	2 ³⁾	6	3,1	4
1	5	9	1,3 ³⁾	35	85	70	38	6 × M5	50	3 ³⁾	6	3,1	4
2	6	9	3,0	45	100	89	52	6 × M6	67	10	8	3,6	5
3	6	9	5,5	60	125	105	65	6 × M8	84	13	10	4,1	5
4	7	9	5,5	60	152	125	78	6 × M10	97	13	12	4,1	6,5
5	8	9	5,5	60	171	155	90	6 × M12	109	13	14	4,6	6,5
6	–	9	–	55	183	160	108	6 × M12	–	–	16	5,1	7
7	–	9	–	70	213	200	135	6 × M16	–	–	18	5,6	8
8	–	9	–	70	254	230	160	6 × M20	–	–	20	6,1	8
9	–	9	–	90	292	315	225	6 × M24	–	–	20	6,1	10

1) above ∅ 16 keyway to DIN 6885/3

2) above ∅ 22 keyway to DIN 6885/3

3) hexagon socket countersunk head cap screw to DIN 7991

We reserve the right to make dimensional and design alterations.

Order example:

To be included when ordering, please state:	size	Type	bore ∅ d ^{H7}	keyway to DIN	with limit switch
Order number:		400. _ 00. 1			see page 58

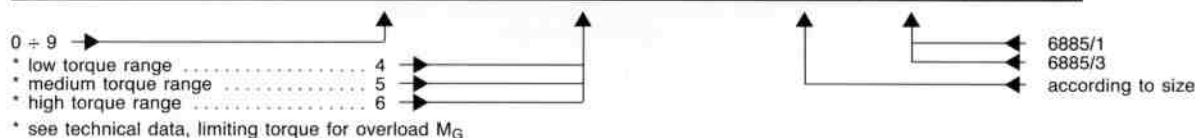

Example: Order number 3 / 400.600.1 / 40 / 6885-1 plus limit switch 055.000.5

Sprock

Type 410. _ 00.0

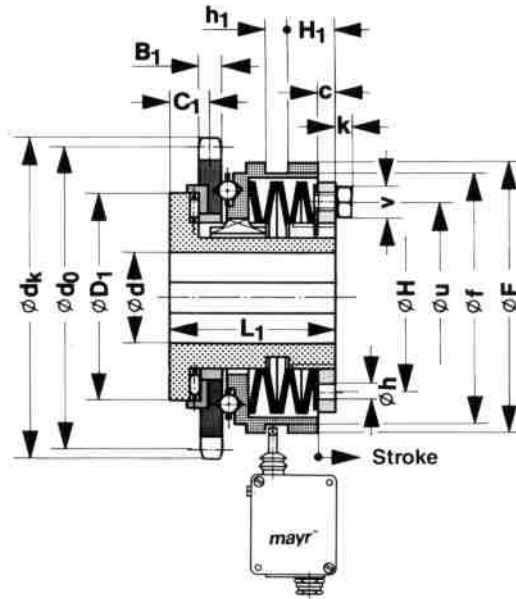

sizes 0 – 5 Type 410. _ 00.0

Technical data

size	Limiting torques for overload M_G			Max. speeds		Weight pilot bored kg	Stroke of the control element in the event of an overload mm
	Type 410.400.0 Nm	Type 410.500.0 Nm	Type 410.600.0 Nm	Type 410.400.0 410.500.0 rpm	Type 410.600.0 rpm		
0	2,5 – 5	5 – 10	10 – 20	4300	2150	0,45	1,4
1	6 – 12	12 – 25	25 – 50	2880	1440	1,3	2,3
2	12 – 25	25 – 50	50 – 100	2360	1180	2,3	2,6
3	25 – 50	50 – 100	100 – 200	2000	1000	4,1	2,6
4	50 – 100	100 – 200	200 – 400	1660	830	7,9	3,7
5	87 – 175	175 – 350	350 – 700	1360	680	14,0	4,6

Table of dimensions

size	Number of teeth z	Chain sprocket pitch "	Internal width of chain "	Pitch t	Addendum circle d_k	Pitch circle d_0	Width B_1	C_1	c	D_1	d_{min}
0	17	1/2	3/16	12,7	75,0	69,11	4,4	8,2	5,5	40	8
1	22	1/2	5/16	12,7	95,0	89,24	7,0	11,5	7	59	11
2	27	1/2	5/16	12,7	115,0	109,40	7,0	13,5	7	77	15
3	22	3/4	7/16	19,05	142,5	133,86	10,5	17,8	10	89,5	19
4	21	1	17	25,4	182,0	170,43	15,3	23,7	11	104	25
5	24	1	17	25,4	206,0	194,59	15,3	24,7	12	119,5	30

size	d_{max}	F	f	H	H_1	h	h_1	k	L_1	u	v
0	20 ¹⁾	55	50	37	8	3	9	– ³⁾	34,5	37	2 ³⁾
1	25 ²⁾	82	72	50	12	5	9	1,3 ³⁾	48	50	3 ³⁾
2	35	100	90	67	14	6	9	3,0	56	67	10
3	45	120	112	84	21	6	9	5,5	73	84	13
4	55	146	140	104	27	7	9	5,5	93	97	13
5	65	176	170	125	33	8	9	5,5	107	109	13

1) above \varnothing 16 keyway to DIN 6885/3

2) above \varnothing 22 keyway to DIN 6885/3

3) hexagon socket countersunk head cap screw to DIN 7991

We reserve the right to make dimensional and design alterations.

Order example:

To be included when ordering, please state:	size	Type	bore \varnothing d^{H7}	keyway to DIN	with limit switch
Order number:		410. _ 00.0			see page 58

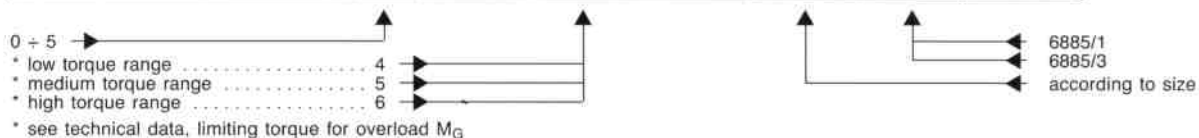

Example: Order number 1 / 410.600.0 / 18 / 6885-1 plus limit switch 055.000.5

Lastic

Type 437._00.0

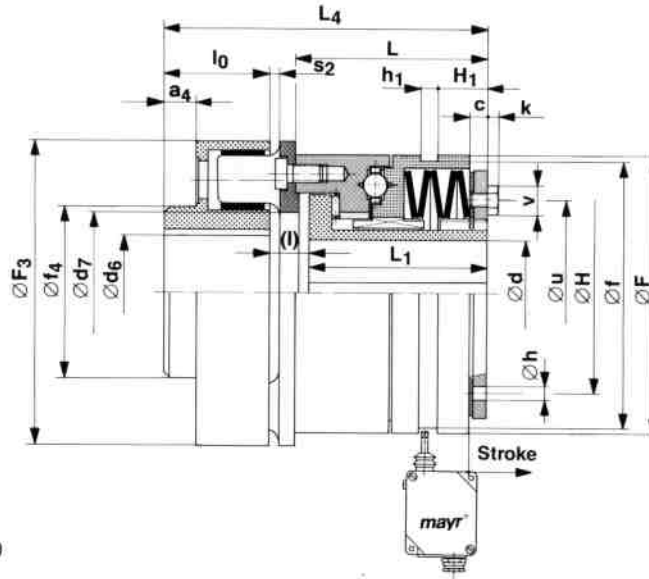

sizes 0-5 Type 437._00.0

Technical data

size	Limiting torques for overload M_G			Max. speeds		Rated torque of flexible coupling T_{KN} 4)	Weight pilot bored	Stroke of the control element in the event of an overload	Mass moments of inertia	
	Type 437.400.0	Type 437.500.0	Type 437.600.0	Type 437.400.0 437.500.0	Type 437.600.0				Flexible side	Hub side
	Nm	Nm	Nm	rpm	rpm	Nm	kg	mm	kgm ²	kgm ²
0	2,5 – 5	5 – 10	10 – 20	4300	2150	75	1,5	1,4	0,00081	0,00010
1	6 – 12	12 – 25	25 – 50	2880	1440	150	3,8	2,3	0,00370	0,00067
2	12 – 25	25 – 50	50 – 100	2360	1180	150	4,8	2,6	0,00441	0,00190
3	25 – 50	50 – 100	100 – 200	2000	1000	300	9,2	2,6	0,01233	0,00517
4	50 – 100	100 – 200	200 – 400	1660	830	600	14,8	3,7	0,02568	0,01631
5	87 – 175	175 – 350	350 – 700	1360	680	1200	27,0	4,6	0,06765	0,04162

Table of dimensions

size	a_4	c	d_{min}	d_{max}	d_6_{min}	d_6_{max}	d_7	F	F_3	f	f_4	H
0	7	5,5	8	20 ¹⁾	11	30	35	55	80	50	50	37
1	10	7	11	25 ²⁾	11	42	50	82	105	72	65	50
2	10	7	15	35	11	42	65	100	105	90	65	67
3	19	10	19	45	13	60	80	120	135	112	85	84
4	17	11	25	55	25	60	88	146	160	140	90	104
5	35	12	30	65	30	75	110	176	198	170	115	125

size	H_1	h	h_1	k	L	L_1	L_4	l	l_0	s_2	u	v
0	8	3	9	– ³⁾	38,5	34,5	89,5	25	30	4	37	2 ³⁾
1	12	5	9	1,3 ³⁾	52	48	116	26	42	4	50	3 ³⁾
2	14	6	9	3,0	61	56	125	27	42	4	67	10
3	21	6	9	5,5	78	73	159	31	55	4	84	13
4	27	7	9	5,5	99,5	93	168,5	20,5	55	6	97	13
5	33	8	9	5,5	113,5	107	211,5	22,5	82	6	109	13

1) above $\varnothing 16$ keyway to DIN 6885/3
2) above $\varnothing 22$ keyway to DIN 6885/3

3) hexagon socket countersunk head cap screw to DIN 7991
4) $T_{Kmax} = 3,0 \times T_{KN}$

We reserve the right to make dimensional and design alterations.

Order example:

To be included when ordering, please state:	size	Type	bore $\varnothing d_{H7}$	keyway to DIN	bore $\varnothing d_e^{H7}$	keyway to DIN	with limit switch
Order number:		437._00.0					see page 58



Example: Order number 3 / 437.500.0 / 35 / 6885-1 / 50 / 6885-1 plus limit switch 055.000.5

Positive detachable

Type 435._00.0

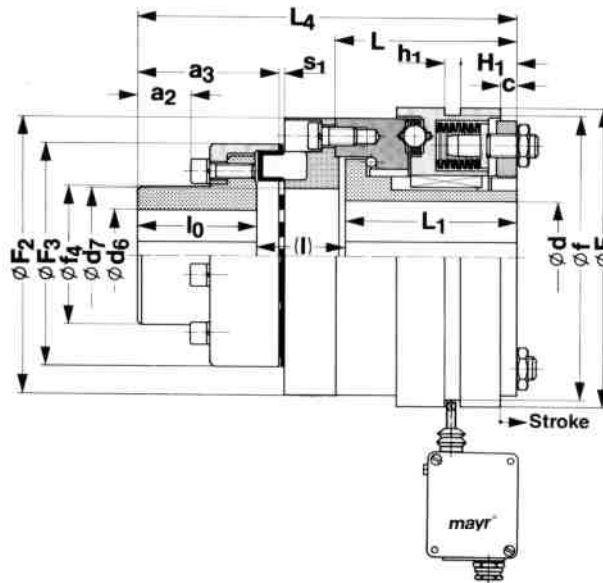

sizes 6–9 Type 435._00.0

Technical data

size	Limiting torques for overload M_G			Max. speeds		Weight pilot bored kg	Rated torque of positive flexible coupling $T_{KN}^{1)}$ Nm	Stroke of the control element in the event of an overload mm	Mass moments of inertia	
	Type 435.400.0 Nm	Type 435.500.0 Nm	Type 435.600.0 Nm	Type 435.400.0 435.500.0 rpm	Type 435.600.0 rpm				Flexible side kgm ²	Hub side kgm ²
6	150 – 300	300 – 600	600 – 800	1200	600	33,3	417	5	0,07993	0,07687
7	250 – 500	500 – 1000	1000 – 2000	960	480	63,9	1120	6	0,25204	0,19676
8	425 – 850	850 – 1700	1700 – 3400	840	420	99,7	1670	7	0,51589	0,50121
9	750 – 1500	1500 – 3000	3000 – 6000	600	300	209,0	5550	8	1,96661	1,84999

Table of dimensions

size	a_2	a_3	c	d_{min}	d_{max}	d_6_{min}	d_6_{max}	d_7	F	F_2	F_3
6	36	92,5	11	40	75	–	60	90	200	186	148
7	49	117,5	15	50	100	–	75	115	240	240	194
8	53,4	129	18	60	120	–	85	130	285	270	214
9	80,8	176	21	70	150	60	115	170	380	360	295

size	f	f_4	H_1	h_1	L	L_1	L_4	l_0	l	s_1
6	190	92,5	38	9	119	112	249	78	59	$3,5 \pm 1$
7	230	121,5	46	9	141	133	307	97	77	$3,5 \pm 1,5$
8	275	135,5	53	9	172	164	357,5	107	86,5	$4,0 \pm 2$
9	370	181	75	9	190	180	437,5	147	110,5	$8,0 \pm 2,5$

1) $T_{Kmax} = 1,8 \times T_{KN}$

We reserve the right to make dimensional and design alterations.

Order example:

To be included when ordering, please state:	size	Type	bore $\varnothing d_{H7}$	keyway to DIN	bore $\varnothing d_6^{H7}$	keyway to DIN	with limit switch
Order number:		435._00.0					see page 58



Example: Order number 7 / 435.600.0 / 80 / 6885-1 / 60 / 6885-1 plus limit switch 055.000.5

Torsionally rigid

Type 436. _ 00.8

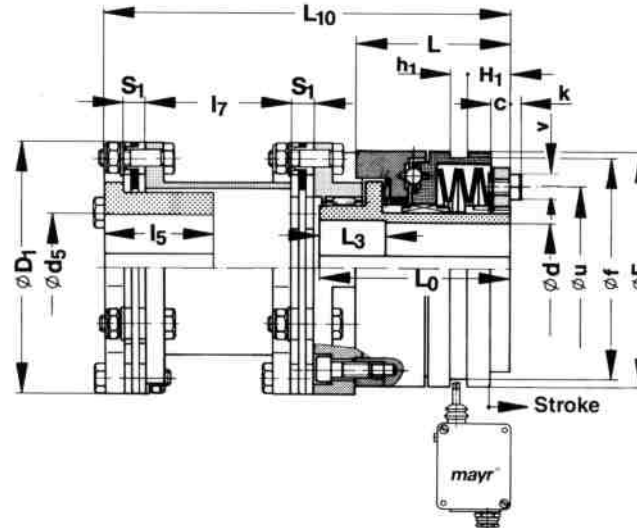

sizes 0 – 5 Type 436. _ 00.8

Technical data

size	Limiting torques for overload M_G			Max. speeds		Weight pilot bored kg	Rated torque of torsionally rigid flexible coupling T_{KN} Nm	Stroke of the control element in the event of an overload mm	Mass moments of inertia	
	Type 436.400.8 Nm	Type 436.500.8 Nm	Type 436.600.8 Nm	Type 436.400.8 436.500.8 rpm	Type 436.600.8 rpm				Flexible side kgm ²	Hub side kgm ²
0	2,5 – 5	5 – 10	10 – 20	4300	2150	1,9	30	1,4	0,00072	0,00011
1	6 – 12	12 – 25	25 – 50	2880	1440	3,4	50	2,3	0,00255	0,0007
2	12 – 25	25 – 50	50 – 100	2360	1180	5,5	100	2,6	0,00460	0,00205
3	25 – 50	50 – 100	100 – 200	2000	1000	9,9	200	2,6	0,01441	0,00541
4	50 – 100	100 – 200	200 – 400	1660	830	18,0	400	3,7	0,02872	0,01711
5	87 – 175	175 – 350	350 – 700	1360	680	31,5	1000	4,6	0,08552	0,04281

Table of dimensions

size	c	D ₁	d _{min}	d _{max}	d _{5 min}	d _{5 max}	F	f	H ₁	h ₁
0	5,5	80	8	20 ¹⁾	8	28 ³⁾	55	50	8	9
1	7	92	11	25 ²⁾	8	38 ⁴⁾	82	72	12	9
2	7	102	15	35	12	45	100	90	14	9
3	10	128	19	45	15	55	120	112	21	9
4	11	145	25	55	20	65	146	140	27	9
5	12	180	30	65	26	80	176	170	33	9

size	k	L	L ₀	L ₃	L ₁₀	l ₅	l ₇	S ₁	u	v
0	– ⁵⁾	38,5	51	15	122,5	35	44	8	37	2 ⁵⁾
1	1,3 ⁵⁾	52	70	20	146	40	54	8	50	3 ⁵⁾
2	3,0	61	78	25	169	45	64	8	67	10
3	5,5	78	96	30	204	55	74	11	84	13
4	5,5	99,5	124	30	254,5	65	94	11	97	13
5	5,5	113,5	140	30	300,5	80	110	15	109	13

- 1) above $\varnothing 16$ keyway to DIN 6885/3
- 2) above $\varnothing 22$ keyway to DIN 6885/3
- 3) above $\varnothing 23$ keyway to DIN 6885/3
- 4) above $\varnothing 35$ keyway to DIN 6885/3
- 5) hexagon socket countersunk head cap screw to DIN 7991

We reserve the right to make dimensional and design alterations.

Order example:

To be included when ordering, please state:	size	Type	bore $\varnothing d^{H7}$	keyway to DIN	bore $\varnothing d_5^{H7}$	keyway to DIN	with limit switch
Order number:		436. _ 00.8					see page 58



Example: Order number 0 / 436.600.8 / 18 / 6885-3 / 25 / 6885-3 plus limit switch 055.000.5

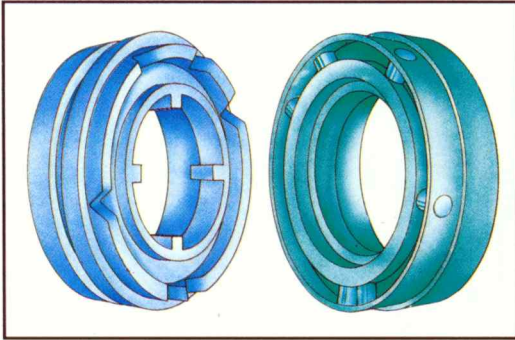

Operating principle of the EAS[®]-synchronous clutch

- * The EAS[®]-synchronous clutch disengages when the pre-set limiting torque is achieved.
- * After removal of the overload the clutch re-engages at the same position of disengagement after rotation through 360°. Additional engaging positions e. g. 45°, 60°, 90°, 120° or 180° are also available.

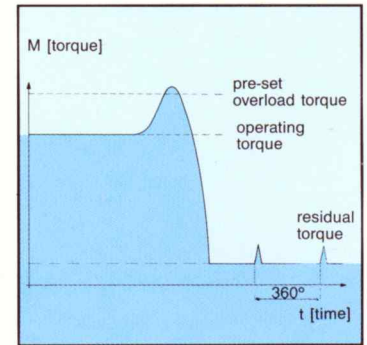

Switching behaviour

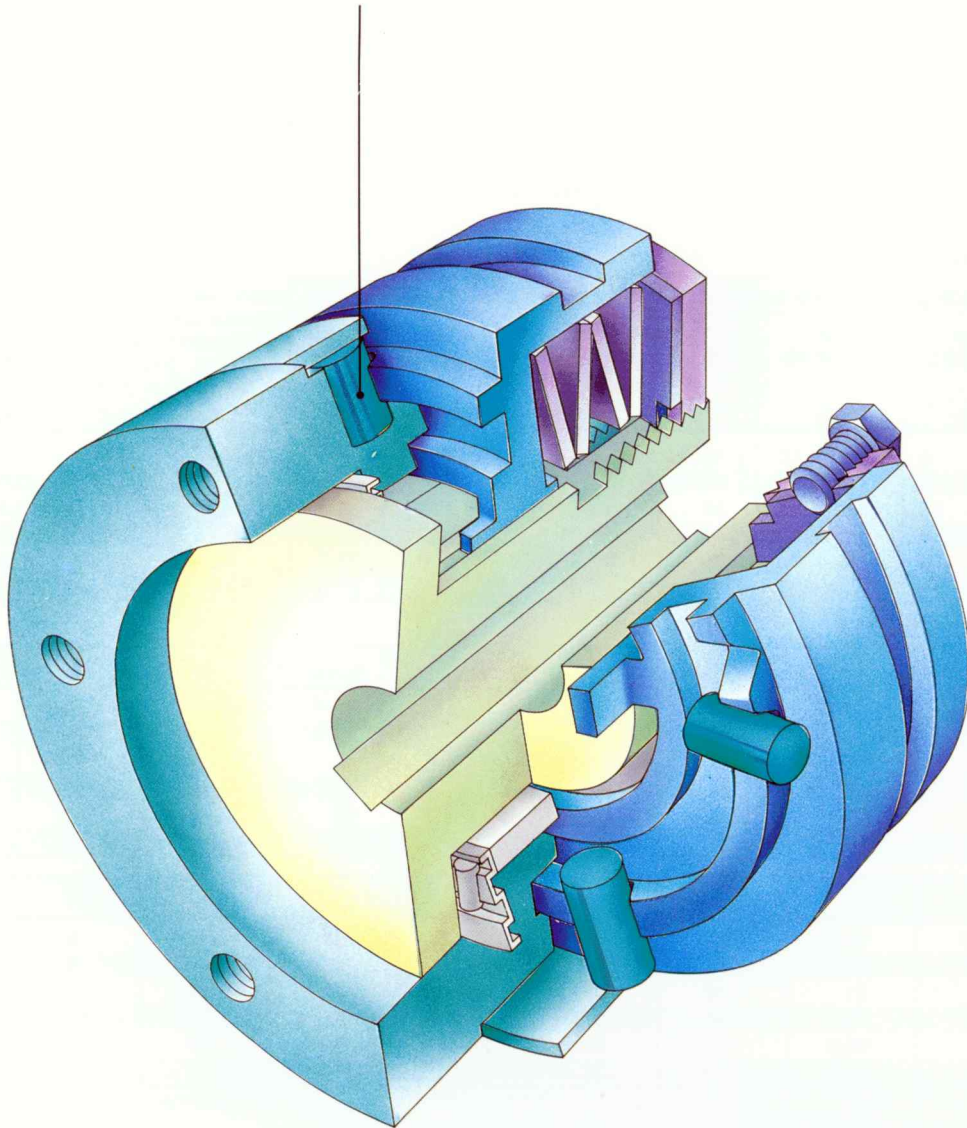

The accurate safety clutch

- * Re-engagement is always guaranteed at a known position due to the special mayr-synchronous geometry of the mayr-precision rollers and roller fits.

Summary of types

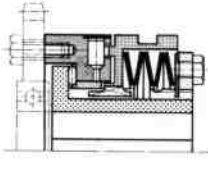
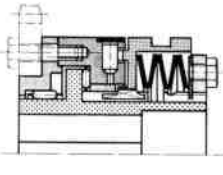
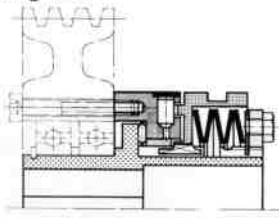
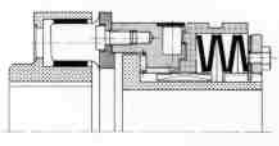
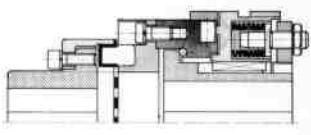
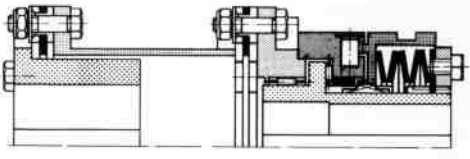
EAS [®] -clutch	Type	Torque (Nm)	Application
EAS[®]-flanged version 	400._05.0	5 ÷ 4000	For fitting drive elements such as chain sprockets, gears, toothed belt pulleys, V-belt pulleys, etc. The drive element and bearing are customer supply. page 20
EAS[®]-short supported hub 	400._05.5	5 ÷ 4000	EAS [®] -clutch with fitted bearing to take single, symmetrical and narrow drive elements (chain sprocket, gear, single-groove V-belt pulley, etc). Provision of an additional bearing for the drive element by the customer becomes unnecessary. Clutch, which can easily be pushed on. page 22
EAS[®]-long projecting hub 	400._05.1	5 ÷ 4000	The bearing of the drive element can be carried out by the customer to suit his own application. Suitable for wide, projecting drive elements; ball bearing or bronze bushing possible. Compact design – very advantageous also for short shaft ends. page 24
EAS[®]-Lastic 	437._05.0	5 ÷ 1400	Torsionally flexible overload clutch for connecting two shafts. The flexible coupling element is designed as a simple push-on coupling, permitting easy fitting and removal of the clutch. page 26
EAS[®]-positive 	435._05.0	300 ÷ 4000	Positive, torsionally flexible overload clutch for connecting two shafts. The flexible coupling section is designed as a torsionally flexible, resilient slip-on coupling. The coupling has axial, radial, angular and torsional resiliences. page 27
EAS[®]-torsionally rigid 	436._05.8	5 ÷ 4000	Torsionally rigid overload clutch for connecting two shafts. Flexible coupling section designed as a torsionally rigid, all-steel coupling. The coupling can absorb angular, radial and axial misalignments; the coupling is torsionally rigid in the direction of rotation. page 28
Electrical accessories			Limit switch, pages 58 to 60

Flanged version

Type 400._05.0

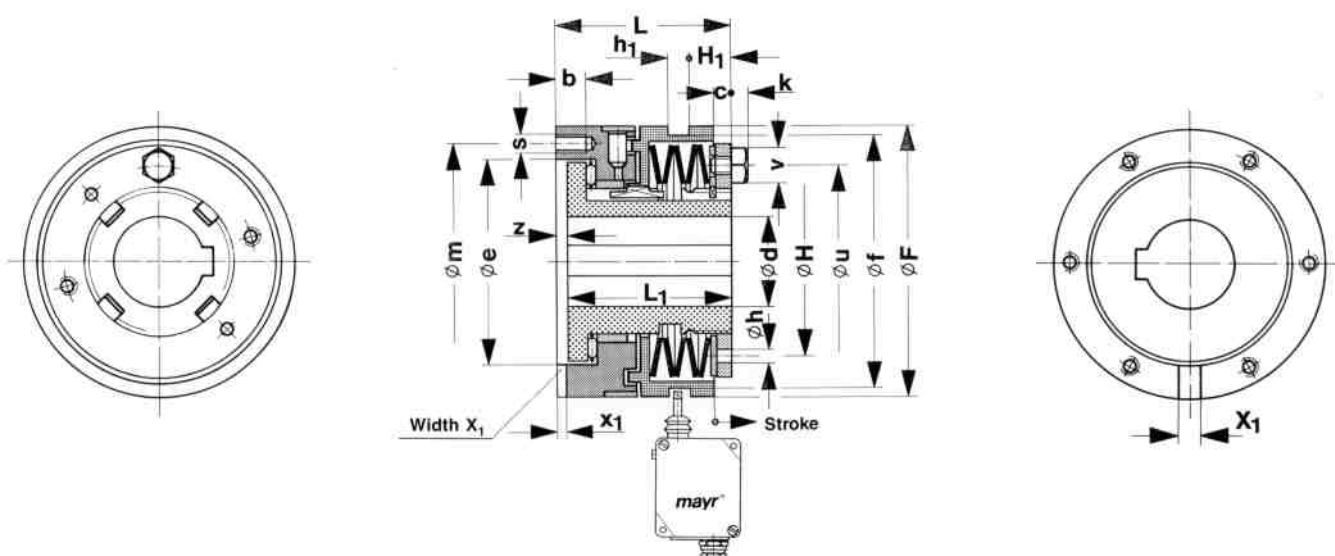

sizes 0-5 Type 400._05.0

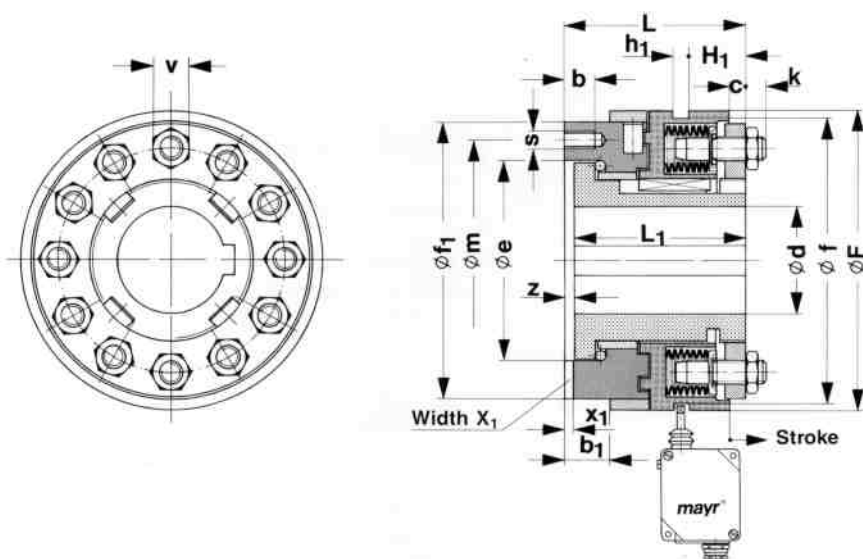

sizes 6-8 Type 400._05.0

Technical data

size	Limiting torques for overload M_G			Max. ratchetting speed *			Weight pilot bored kg	Stroke of the control element in the event of an overload mm	Mass moments of inertia	
	Type 400.405.0 Nm	Type 400.505.0 Nm	Type 4) 400.605.0 Nm	Type 400.405.0 rpm	Type 400.505.0 rpm	Type 4) 400.605.0 rpm			Pressure flange side kgm ²	Hub side kgm ²
0	5 – 10	10 – 20	20 – 40	1430	710	350	0,5	1,2	0,00009	0,00010
1	12 – 25	25 – 50	50 – 100	960	480	240	1,5	1,8	0,00062	0,00067
2	25 – 50	50 – 100	100 – 200	790	390	200	2,7	2,0	0,00149	0,00190
3	50 – 100	100 – 200	200 – 400	660	330	160	4,7	2,2	0,00380	0,00517
4	100 – 200	200 – 400	400 – 800	550	270	130	9,8	2,5	0,00998	0,01631
5	175 – 350	350 – 700	700 – 1400	400	200	100	16	3,0	0,02345	0,04162
6	300 – 600	600 – 1200	–	300	150	–	21	3,5	0,03961	0,07689
7	500 – 1000	1000 – 2000	–	200	100	–	37	4,0	0,09693	0,19679
8	850 – 1700	1700 – 4000	–	100	50	–	63	4,5	0,23582	0,50111

* The max. operating speeds correspond to the max. speeds of the ratchetting clutch, see page 8.

Table of dimensions

size	b	b ₁	c	d _{min}	d _{max}	e	F	f	f ₁	H	H ₁	h
0	6,5	-	5,5	8	20 ¹⁾	41	55	50	-	37	7,5	3
1	8,5	-	7	11	25 ²⁾	60	82	72	-	50	12	5
2	10	-	7	15	35	78	100	90	-	67	14	6
3	14	-	10	19	45	90,5	120	112	-	84	21	6
4	16	-	11	25	55	105	146	140	-	104	27	7
5	20	-	12	30	65	120,5	176	170	-	125	33	8
6	20	26	11	40	75	136	200	190	186	-	38	-
7	25	30	15	50	100	168	240	230	227	-	46	-
8	30	40	18	60	120	198	285	275	266	-	53	-

size	h ₁	k	L	L ₁	m	s	u	v	X ₁ ^{P9}	x ₁	z
0	9	- ³⁾	38,5	34,5	48	6 × M5	37	2 ³⁾	6	3,1	4
1	9	1,3 ³⁾	52	48	70	6 × M5	50	3 ³⁾	6	3,1	4
2	9	3,0	61	56	89	6 × M6	67	10	8	3,6	5
3	9	5,5	78	73	105	6 × M8	84	13	10	4,1	5
4	9	5,5	99,5	93	125	6 × M10	97	13	12	4,1	6,5
5	9	5,5	113,5	107	155	6 × M12	109	13	14	4,6	6,5
6	9	16	119	112	160	6 × M12	-	24	16	5,1	7
7	9	15	141	133	200	6 × M16	-	30	18	5,6	8
8	9	12	172	164	230	6 × M20	-	30	20	6,1	8

1) above ∅ 16 keyway to DIN 6885/3

2) above ∅ 22 keyway to DIN 6885/3

3) hexagon socket countersunk head cap screw to DIN 7991

4) Type 400.605.0 sizes 0 – 5 only

We reserve the right to make dimensional and design alterations.

Order example:

To be included when ordering, please state:	size	Type	bore ∅ d ^{H7}	keyway to DIN	with limit switch
Order number:		400. _ 05.0			see page 58

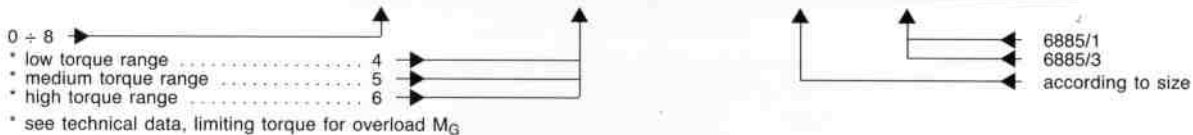

Example: Order number 3 / 400.605.0 / 30 / 6885-1 plus limit switch 055.000.5

Short supported hub

Type 400._05.5

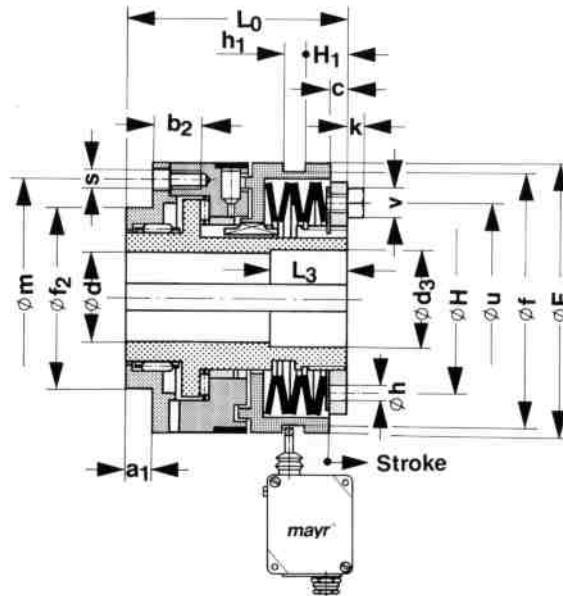

sizes 0–5 Type 400._05.5

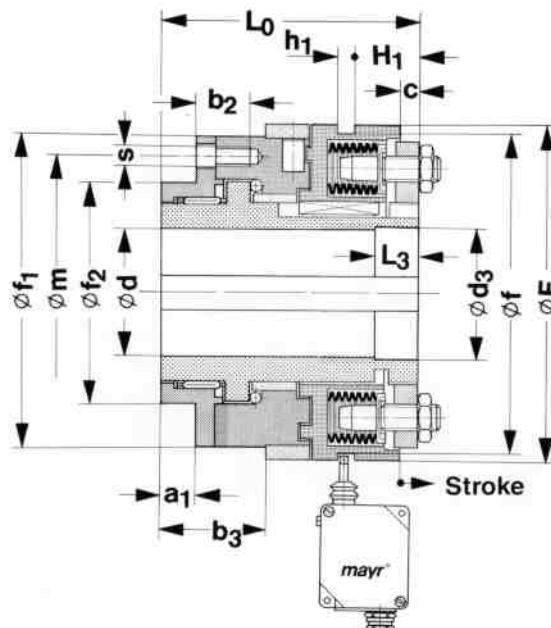

sizes 6–8 Type 400._05.5

Technical data

size	Limiting torques for overload M_G			Max. ratchetting speed *			Weight pilot bored kg	Stroke of the control element in the event of an overload mm	Mass moments of inertia	
	Type 400.405.5 Nm	Type 400.505.5 Nm	Type 4) 400.605.5 Nm	Type 400.405.5 rpm	Type 400.505.5 rpm	Type 4) 400.605.5 rpm			Pressure flange side kgm ²	Hub side kgm ²
0	5 – 10	10 – 20	20 – 40	1430	710	350	0,7	1,2	0,00012	0,00011
1	12 – 25	25 – 50	50 – 100	960	480	240	2	1,8	0,00091	0,00070
2	25 – 50	50 – 100	100 – 200	790	390	200	3	2,0	0,00182	0,00205
3	50 – 100	100 – 200	200 – 400	660	330	160	6	2,2	0,00484	0,00541
4	100 – 200	200 – 400	400 – 800	550	270	130	12	2,5	0,01429	0,01711
5	175 – 350	350 – 700	700 – 1400	400	200	100	20	3,0	0,03095	0,04281
6	300 – 600	600 – 1200	–	300	150	–	26	3,5	0,05466	0,07886
7	500 – 1000	1000 – 2000	–	200	100	–	44	4,0	0,12383	0,20268
8	850 – 1700	1700 – 4000	–	100	50	–	78	4,5	0,33589	0,51380

* The max. operating speeds correspond to the max. speeds of the ratchetting clutch, see page 10.

Table of dimensions

size	a ₁	b ₂	b ₃	c	d _{min}	d _{max}	d ₃	F	f	f ₁	f ₂ h6
0	8	11	–	5,5	8	20 ¹⁾	21	55	50	–	38
1	10	16,5	–	7	11	25 ²⁾	26	82	72	–	50
2	12	15	–	7	15	35	36	100	90	–	60
3	12	20	–	10	19	45	46	120	112	–	80
4	16	23,5	–	11	25	55	56	146	140	–	100
5	18	28,5	–	12	30	65	66	176	170	–	120
6	20	31	57	11	40	75	76	200	190	186	130
7	25	34	64	15	50	100	101	240	230	227	160
8	30	48	88	18	52	120	121	285	275	266	190

size	H	H ₁	h	h ₁	k	L ₀	L ₃	m	s	u	v
0	37	7,5	3	9	– ³⁾	51	15	48	6 × M5	37	2 ³⁾
1	50	12	5	9	1,3 ³⁾	70	20	70	6 × M5	50	3 ³⁾
2	67	14	6	9	3,0	78	25	89	6 × M6	67	10
3	84	21	6	9	5,5	96	30	105	6 × M8	84	13
4	104	27	7	9	5,5	124	30	125	6 × M10	97	13
5	125	33	8	9	5,5	140	30	155	6 × M12	109	13
6	–	38	–	9	–	150	25	160	6 × M12	–	–
7	–	46	–	9	–	175	35	200	6 × M16	–	–
8	–	53	–	9	–	220	40	230	6 × M20	–	–

1) above ∅ 16 keyway to DIN 6885/3

2) above ∅ 22 keyway to DIN 6885/3

3) hexagon socket countersunk head cap screw to DIN 7991

4) Type 400.605.0 only sizes 0–5

We reserve the right to make dimensional and design alterations.

Order example:

To be included when ordering, please state:	size	Type	bore ∅ dH7	keyway to DIN	with limit switch
Order number:		400. _ 05.5			see page 58

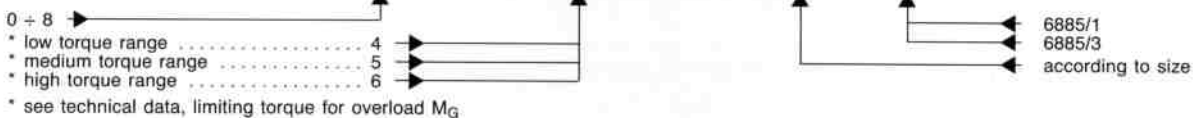

Example: Order number 2 / 400.405.5 / 20 / 6885-1 plus limit switch 055.000.5

Long projecting hub

Type 400._05.1

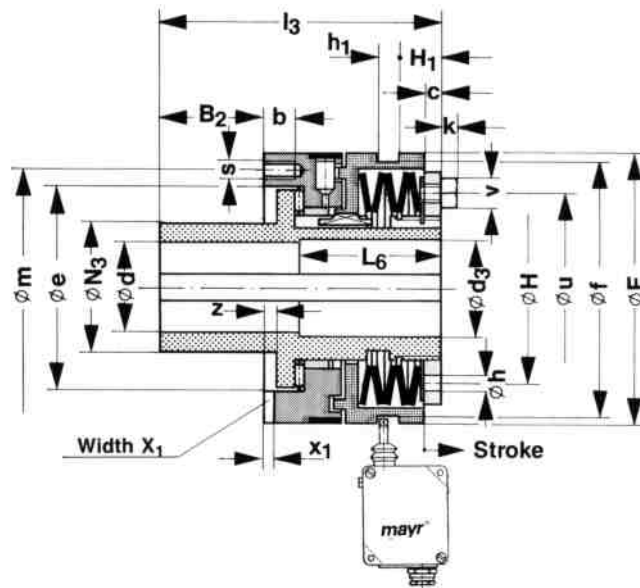

sizes 0–5 Type 400._05.1

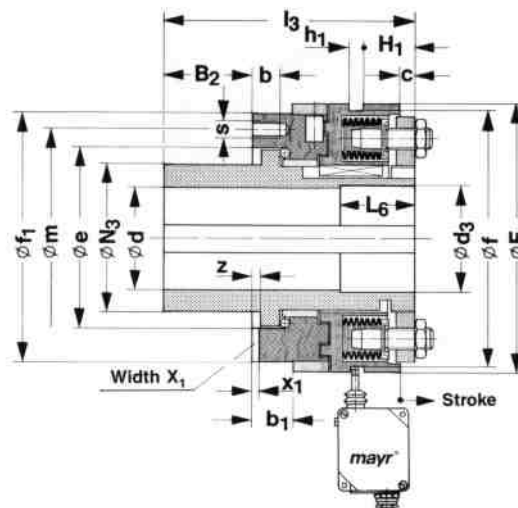

sizes 6–8 Type 400._05.1

Technical data

size	Limiting torques for overload M _G			Max. ratchetting speed *			Weight pilot bored kg	Stroke of the control element in the event of an overload mm	Mass moments of inertia	
	Type 400.405.1 Nm	Type 400.505.1 Nm	Type 4) 400.605.1 Nm	Type 400.405.1 rpm	Type 400.505.1 rpm	Type 4) 400.605.1 rpm			Pressure flange side kgm ²	Hub side kgm ²
0	5 – 10	10 – 20	20 – 40	1430	710	350	0,65	1,2	0,00009	0,00011
1	12 – 25	25 – 50	50 – 100	960	480	240	1,8	1,8	0,00062	0,00072
2	25 – 50	50 – 100	100 – 200	790	390	200	3,4	2,0	0,00144	0,00214
3	50 – 100	100 – 200	200 – 400	660	330	160	4,7	2,2	0,00381	0,00570
4	100 – 200	200 – 400	400 – 800	550	270	130	12	2,5	0,00998	0,01769
5	175 – 350	350 – 700	700 – 1400	400	200	100	19	3,0	0,02345	0,04393
6	300 – 600	600 – 1200	–	300	150	–	25,5	3,5	0,03961	0,08253
7	500 – 1000	1000 – 2000	–	200	100	–	45,0	4,0	0,09693	0,21088
8	850 – 1700	1700 – 4000	–	100	50	–	75,5	4,5	0,23582	0,53181

* The max. operating speeds correspond to the max. speeds of the ratchetting clutch, see page 12.

Table of dimensions

size	B ₂	b	b ₁	c	d _{min}	d _{max}	d ₃	e	F	f	f ₁	H	H ₁
0	27,5	6,5	–	5,5	8	20 ¹⁾	21	41	55	50	–	37	7,5
1	33	8	–	7	11	25 ²⁾	26	60	82	72	–	50	12
2	39	10	–	7	15	35	36	78	100	90	–	67	14
3	47	12	–	10	19	45	46	90,5	120	112	–	84	21
4	52,5	16	–	11	25	55	56	105	146	140	–	104	27
5	57,5	20	–	12	30	65	66	120,5	176	170	–	125	33
6	64	20	26	11	40	75	76	136	200	190	186	–	38
7	72	25	30	15	50	100	101	168	240	230	227	–	46
8	82	30	40	18	52	120	121	198	285	275	266	–	53

size	h	h ₁	k	L ₆	l ₃	m	N _{3 r7}	s	u	v	X ₁ ^{P9}	x ₁	z
0	3	9	– ³⁾	25	66	48	28	6 × M5	37	2 ³⁾	6	3,1	4
1	5	9	1,3 ³⁾	35	85	70	38	6 × M5	50	3 ³⁾	6	3,1	4
2	6	9	3,0	45	100	89	52	6 × M6	67	10	8	3,6	5
3	6	9	5,5	60	125	105	65	6 × M8	84	13	10	4,1	5
4	7	9	5,5	60	152	125	78	6 × M10	97	13	12	4,1	6,5
5	8	9	5,5	60	171	155	90	6 × M12	109	13	14	4,6	6,5
6	–	9	–	55	183	160	108	6 × M12	–	–	16	5,1	7
7	–	9	–	70	213	200	135	6 × M16	–	–	18	5,6	8
8	–	9	–	70	254	230	160	6 × M20	–	–	20	6,1	8

1) above ∅ 16 keyway to DIN 6885/3

2) above ∅ 22 keyway to DIN 6885/3

3) hexagon socket countersunk head cap screw to DIN 7991

4) Type 400.605.1 only sizes 0 – 5

We reserve the right to make dimensional and design alterations.

Order example:

To be included when ordering, please state:	size	Type	bore ∅ d ^{H7}	keyway to DIN	with limit switch
Order number:		400._05.1			see page 58

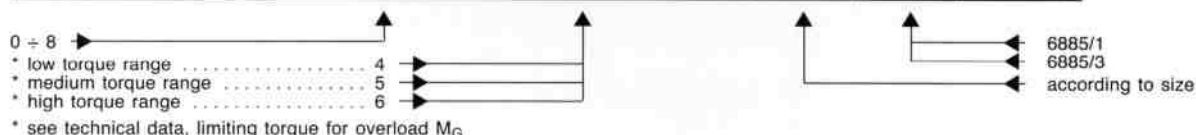

Example: Order number 4 / 400.505.1 / 55 / 6885-1 plus limit switch 055.000.5

Lastic

Type 437. _05.0

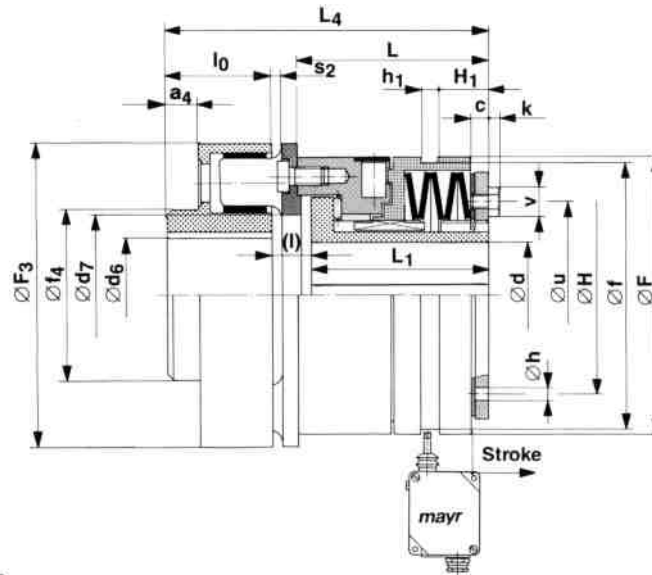

sizes 0-5 Type 437. _05.0

Technical data

size	Limiting torques for overload M_G			Max. ratchetting speed *			Rated torque of flexible coupling $T_{KN}^{4)}$	Weight pilot bored	Stroke of the control element in the event of an overload	Mass moments of inertia	
	Type 437.405.0	Type 437.505.0	Type 437.605.0	Type 437.405.0	Type 437.505.0	Type 437.605.0				Flexible side	Hub side
	Nm	Nm	Nm	rpm	rpm	rpm	Nm	kg	mm	kgm ²	kgm ²
0	5 - 10	10 - 20	20 - 40	1430	710	350	75	1,5	1,2	0,00081	0,00010
1	12 - 25	25 - 50	50 - 100	960	480	240	150	3,8	1,8	0,00370	0,00067
2	25 - 50	50 - 100	100 - 200	790	390	200	150	4,8	2,0	0,00441	0,00190
3	50 - 100	100 - 200	200 - 400	660	330	160	300	9,2	2,2	0,01233	0,00517
4	100 - 200	200 - 400	400 - 800	550	270	130	600	14,8	2,5	0,02568	0,01631
5	175 - 350	350 - 700	700 - 1400	400	200	100	1200	27,0	3,0	0,06765	0,04162

Table of dimensions

size	a_4	c	d_{min}	d_{max}	d_6_{min}	d_6_{max}	d_7	F	F_3	f	f_4	H
0	7	5,5	8	20 ¹⁾	11	30	35	55	80	50	50	37
1	10	7	11	25 ²⁾	11	42	50	82	105	72	65	50
2	10	7	15	35	11	42	65	100	105	90	65	67
3	19	10	19	45	13	60	80	120	135	112	85	84
4	17	11	25	55	25	60	88	146	160	140	90	104
5	35	12	30	65	30	75	110	176	198	170	115	125

size	H_1	h	h_1	k	L	L_1	L_4	l	l_0	s_2	u	v
0	7,5	3	9	- ³⁾	38,5	34,5	89,5	25	30	4	37	2 ³⁾
1	12	5	9	1,3 ³⁾	52	48	116	26	42	4	50	3 ³⁾
2	14	6	9	3,0	61	56	125	27	42	4	67	10
3	21	6	9	5,5	78	73	159	31	55	4	84	13
4	27	7	9	5,5	99,5	93	168,5	20,5	55	6	97	13
5	33	8	9	5,5	113,5	107	211,5	22,5	82	6	109	13

* The max. operating speeds correspond to the max. speeds of the ratchetting clutch, see page 15.

1) above $\varnothing 16$ keyway to DIN 6885/3
2) above $\varnothing 22$ keyway to DIN 6885/3

3) hexagon socket countersunk head cap screw to DIN 7991
4) $T_{Kmax} = 3,0 \times T_{KN}$

We reserve the right to make dimensional and design alterations.

Order example:

To be included when ordering, please state:	size	Type	bore $\varnothing d_{H7}$	keyway to DIN	bore $\varnothing d_6^{H7}$	keyway to DIN	with limit switch
Order number:		437. _05.0					see page 58



Example: Order number 3 / 437.505.0 / 35 / 6885-1 / 50 / 6885-1 plus limit switch 055.000.5

Positive detachable

Type 435._05.0

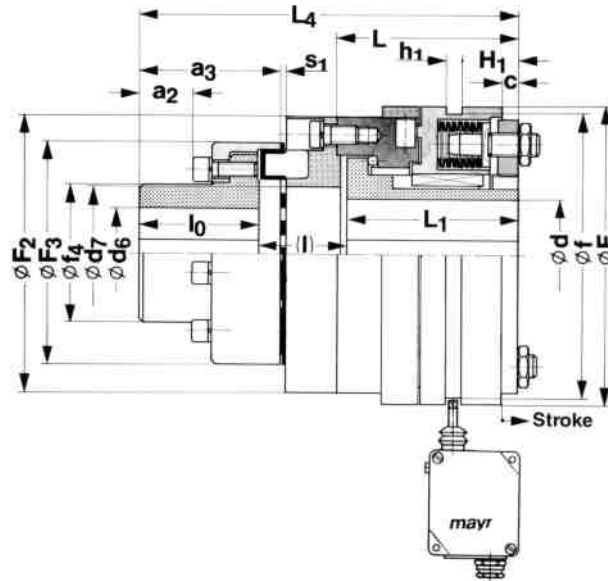

sizes 6-8 Type 435._05.0

Technical data

size	Limiting torques for overload M_G		Max. ratchetting speed *		Weight pilot bored	Rated torque of positive flexible coupling $T_{KN}^{1)}$	Stroke of the control element in the event of an overload	Mass moments of inertia	
	Type 435.405.0	Type 435.505.0	Type 435.405.0	Type 435.505.0				Flexible side	Hub side
	Nm	Nm	rpm	rpm	kg	Nm	mm	kgm ²	kgm ²
6	300 – 600	600 – 800	300	150	33,3	417	3,5	0,07993	0,07687
7	500 – 1000	1000 – 2000	200	100	63,9	1120	4,0	0,25204	0,19676
8	850 – 1700	1700 – 4000	100	50	99,7	1670	4,5	0,51589	0,50121

Table of dimensions

size	a_2	a_3	c	d_{min}	d_{max}	$d_{6 min}$	$d_{6 max}$	d_7	F	F_2	F_3
6	36	92,5	11	40	75	–	60	90	200	186	148
7	49	117,5	15	50	100	–	75	115	240	240	194
8	53,4	129	18	60	120	–	85	130	285	270	214

size	f	f_4	H_1	h_1	L	L_1	L_4	l_0	l	s_1
6	190	92,5	38	9	119	112	249	78	59	$3,5 \pm 1$
7	230	121,5	46	9	141	133	307	97	77	$3,5 \pm 1,5$
8	275	135,5	53	9	172	164	357,5	107	86,5	$4,0 \pm 2$

* The max. operating speeds correspond to the max. speeds of the ratchetting clutch, see page 16.
 1) $T_{K max} = 1,8 \cdot T_{KN}$

We reserve the right to make dimensional and design alterations.

Order example:

To be included when ordering, please state:	size	Type	bore $\varnothing d^{H7}$	keyway to DIN	bore $\varnothing d_6^{H7}$	keyway to DIN	with limit switch
Order number:		435._05.0					see page 58



Example: Order number 6 / 435.505.0 / 50 / 6885-1 / 55 / 6885-1 plus limit switch 055.000.5

Torsionally rigid

Type 436. _ 05.8

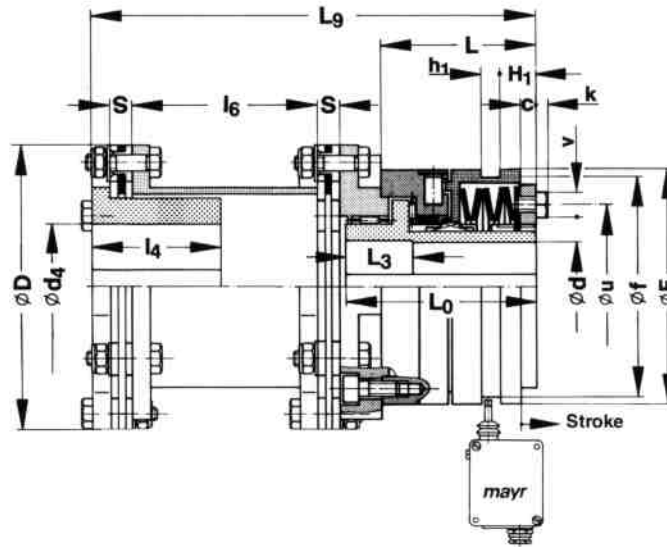

sizes 0-5 Type 436. _ 05.8

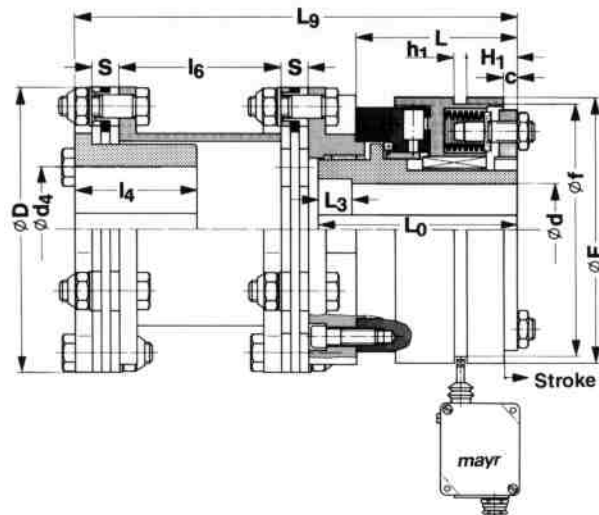

sizes 6-8 Type 436. _ 05.8

Technical data

size	Limiting torques for overload M_G			Max. ratchetting speed *			Weight pilot bored kg	Rated torque of torsionally rigid flex. coupling T_{KN} Nm	Stroke of the control element in the event of an overload mm	Mass moments of inertia	
	Type 436.405.8 Nm	Type 436.505.8 Nm	Type 5) 436.605.8 Nm	Type 436.405.8 rpm	Type 436.505.8 rpm	Type 5) 436.605.8 rpm				Flexible side kgm ²	Hub side kgm ²
0	5 - 10	10 - 20	20 - 40	1430	710	350	2,5	50	1,2	0,00200	0,00011
1	12 - 25	25 - 50	50 - 100	960	480	240	4,0	100	1,8	0,00379	0,00070
2	25 - 50	50 - 100	100 - 200	790	390	200	8,0	200	2,0	0,01204	0,00205
3	50 - 100	100 - 200	200 - 400	660	330	160	12,0	400	2,2	0,02251	0,00541
4	100 - 200	200 - 400	400 - 800	550	270	130	24,9	1000	2,5	0,07199	0,01711
5	175 - 350	350 - 700	700 - 1400	400	200	100	36,0	1600	3,0	0,12419	0,04281
6	300 - 600	600 - 1200	-	300	150	-	49,0	2500	3,5	0,18614	0,07886
7	500 - 1000	1000 - 2000	-	200	100	-	75,5	4000	4,0	0,47600	0,14300
8	850 - 1700	1700 - 4000	-	100	50	-	127,0	6300	4,5	1,15000	0,34000

* The max. operating speeds correspond to the max. speeds of the ratchetting clutch, see page 17.

Torsionally rigid

Type 436. _ 05.8

Table of dimensions

size	c	D	d _{min}	d _{max}	d _{4 min}	d _{4 max}	F	f	H ₁	h ₁
0	5,5	92	8	20 ¹⁾	8	38 ³⁾	55	50	7,5	9
1	7	102	11	25 ²⁾	12	45	82	72	12	9
2	7	128	15	35	15	55	100	90	14	9
3	10	145	19	45	20	65	120	112	21	9
4	11	180	25	55	26	80	146	140	27	8
5	12	200	30	65	29	85	176	170	33	9
6	11	215	40	75	38	90	200	190	38	9
7	15	250	50	100	42	100	240	230	46	9
8	18	300	60	120	52	115	285	275	53	9

size	k	L	L ₀	L ₃	L ₉	l ₄	l ₆	S	u	v
0	- ⁴⁾	38,5	51	15	132,5	40	54	8	37	2 ⁴⁾
1	1,3 ⁴⁾	52	70	20	156	45	64	8	50	3 ⁴⁾
2	3,0	61	78	25	187	55	74	11	67	10
3	5,5	78	96	30	224	65	94	11	84	13
4	5,5	99,5	124	30	281,5	80	110	15	97	13
5	5,5	113,5	140	30	301,5	80	110	15	109	13
6	-	119	150	25	327	90	120	20	-	-
7	-	141	175	35	375	100	124	23	-	-
8	-	172	220	40	447	115	146	27	-	-

- 1) above ∅ 16 keyway to DIN 6885/3
- 2) above ∅ 22 keyway to DIN 6885/3
- 3) above ∅ 35 keyway to DIN 6885/3
- 4) hexagon socket countersunk head cap screw to DIN 7991
- 5) Type 436.605.8 only sizes 0 – 5

We reserve the right to make dimensional and design alterations.

Order example:

To be included when ordering, please state:	size	Type	bore ∅ d ^{H7}	keyway to DIN	bore ∅ d ₄ ^{H7}	keyway to DIN	with limit switch
Order number:		436 . _ 05 . 8					see page 58

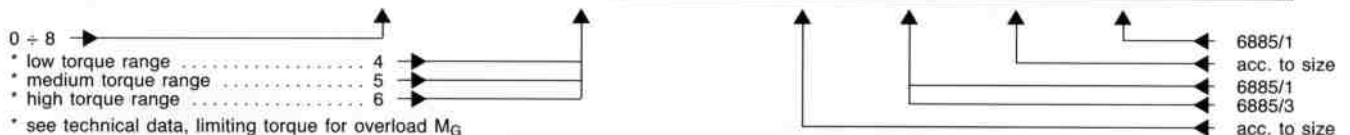

Example: Order number 5 / 436.505.8 / 50 / 6885-1 / 70 / 6885-1 plus limit switch 055.000.5

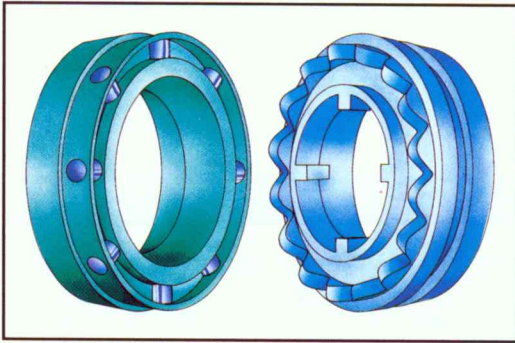

Operating principle of the EAS[®]-overload clutch

- * In the event of a torque overload input and output components disengage and remain disconnected due to the overload mechanism. Disconnected rotating masses free to slow down.
- * After removal of the overload condition the clutch can be re-engaged at any angular position.
- * Re-engagement is done manually or by equipping the clutch with an automatic reset device.

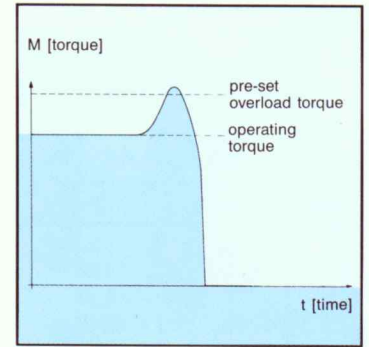

Switching behaviour

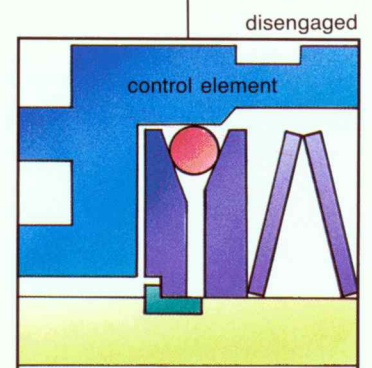
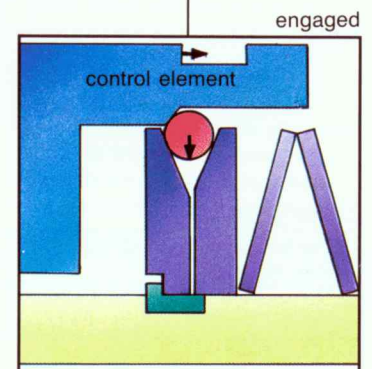
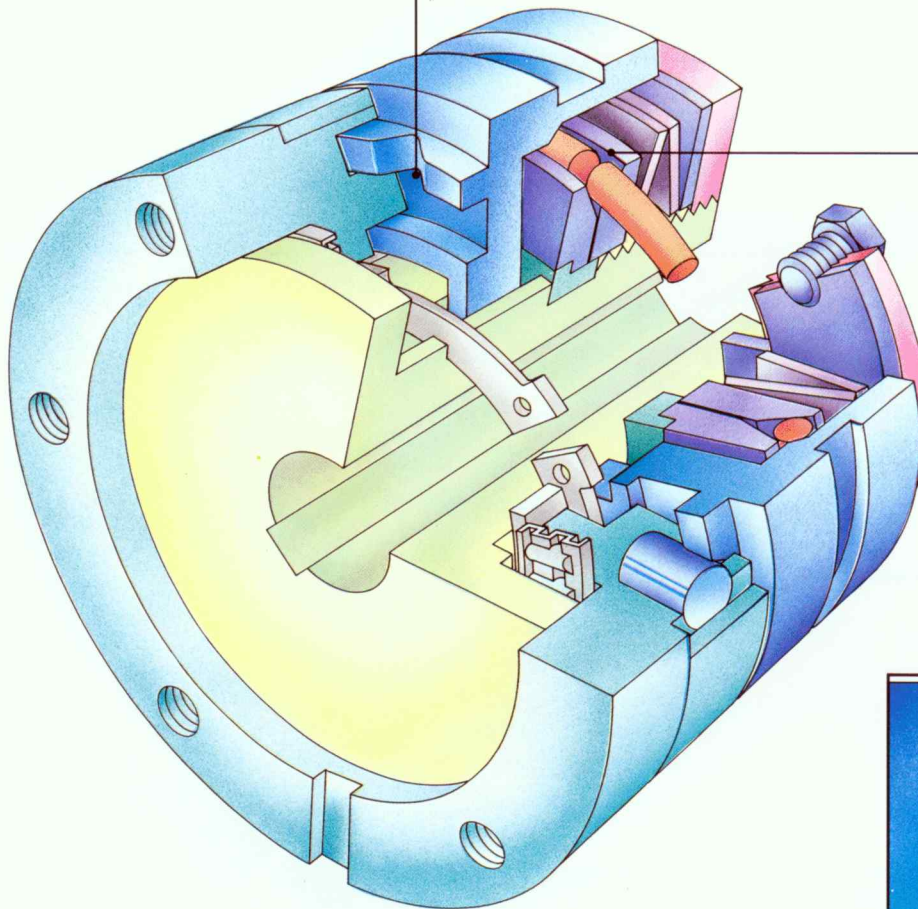

The load disconnecting torque limiting clutch

- * The uniform distribution and the optimised number of mayr-precision rollers and roller seats guarantee a high and uniform supporting component and therefore a long service life of the EAS[®]-overload clutch.
- * In the event of a torque overload disconnected rotation masses free to slow down. Therefore, higher speeds are also possible.

The overload mechanism

- * In the event of an overload the control element moves axially.
- * Switching segments are moved radially to the inside of the control element by axial pressure.
- * The control element is locked into its new axial position.

Summary of types

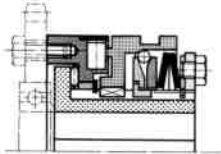
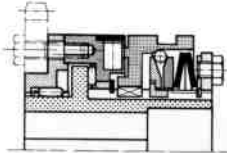
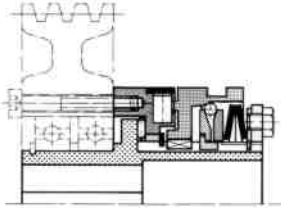
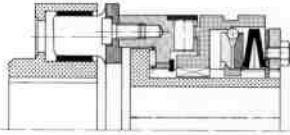
EAS [®] -clutch	Type	Torque (Nm)	Application
EAS[®]-flanged version 	400. _ 14.0	5 ÷ 1400	For fitting drive elements such as chain sprockets, gears, toothed bell pulleys, V-belt pulleys, etc. The drive element and bearing are customer supply. page 32
EAS[®]-short supported hub 	400. _ 14.5	5 ÷ 1400	EAS [®] -clutch with fitted bearing to take single symmetrical and narrow drive elements (chain sprocket, gear, single-groove V-belt pulley etc.). Provision of an additional bearing for the drive element by the customer becomes unnecessary. Clutch, which can easily be pushed on. page 33
EAS[®]-long projecting hub 	400. _ 14.1	5 ÷ 1400	The bearing of the drive element can be carried out by the customer to suit his own application. Suitable for wide, projecting drive elements; ball bearing or bronze bushing possible. Compact design – very advantageous also for short shaft ends. page 34
EAS[®]-Lastic 	437. _ 14.0	5 ÷ 1400	Positive torsionally flexible overload clutch for connecting two shafts. The flexible coupling section is designed as a torsionally flexible, resilient slip-on coupling. The coupling has axial, radial, angular and torsional resiliences. page 35
Electrical accessories			Limit switch pages 58 to 60

Flanged version

Type 400._14.0

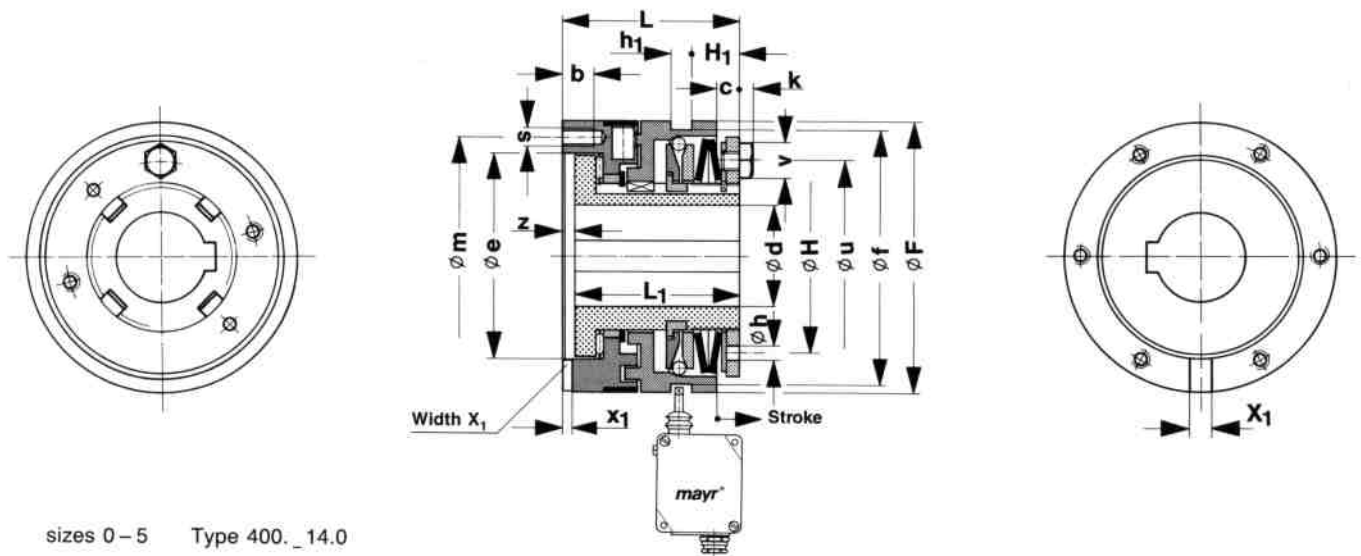

sizes 0 – 5 Type 400._14.0

Technical data

size	Limiting torques for overload M_G			Max. speed n_{max} rpm	Weight pilot bored kg	Stroke of the control element in the event of an overload mm	Mass moments of inertia	
	Type 400.414.0 Nm	Type 400.514.0 Nm	Type 400.614.0 Nm				Pressure flange side kgm ²	Hub side kgm ²
0	5 – 10	10 – 20	20 – 40	6000	0,5	2,2 _{-0,6}	0,00009	0,00010
1	12 – 25	25 – 50	50 – 100	5000	1,5	3 _{-0,7}	0,00062	0,00067
2	25 – 50	50 – 100	100 – 200	4000	2,7	4 ₋₁	0,00149	0,00190
3	50 – 100	100 – 200	200 – 400	3500	4,7	5 _{-1,5}	0,00380	0,00517
4	100 – 200	200 – 400	400 – 800	3000	9,8	5 _{-1,2}	0,00998	0,01631
5	175 – 350	350 – 700	700 – 1400	2300	16,0	6 _{-1,5}	0,02345	0,04162

Table of dimensions

size	b	c	d _{min}	d _{max}	e	F	f	H	H ₁	h	h ₁
0	6,5	5,5	8	20 ¹⁾	41	55	50	37	7,5	3	9
1	8	7	11	25 ²⁾	60	82	72	50	12	5	9
2	10	7	15	35	78	100	90	67	14	6	9
3	12	10	19	45	90,5	120	112	84	21	6	9
4	16	11	25	55	105	146	140	104	27	7	9
5	17	12	30	65	120,5	176	170	125	33	8	9

size	k	L	L ₁	m	s	u	v	X ₁ ^{P9}	x ₁	z
0	– ³⁾	38,5	34,5	48	6 × M5	37	2 ³⁾	6	3,1	4
1	1,3 ³⁾	52	48	70	6 × M5	50	3 ³⁾	6	3,1	4
2	3	61	56	89	6 × M6	67	10	8	3,6	5
3	5,5	78	73	105	6 × M8	84	13	10	4,1	5
4	5,5	99,5	93	125	6 × M10	97	13	12	4,1	6,5
5	5,5	113,5	107	155	6 × M12	109	13	14	4,6	6,5

1) above \varnothing 16 keyway to DIN 6885/3

2) above \varnothing 22 keyway to DIN 6885/3

3) hexagon socket countersunk head cap screw to DIN 7991

We reserve the right to make dimensional and design alterations.

Order example:

To be included when ordering, please state:	size	Type	bore \varnothing d ^{H7}	keyway to DIN	with limit switch
Order example:		400._14.0			see page 58

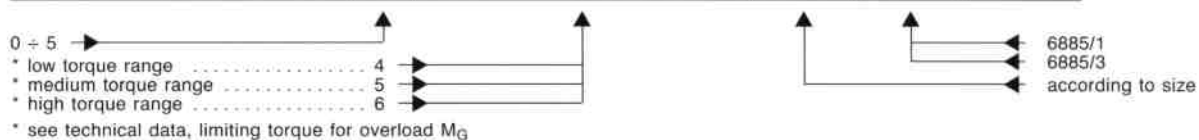

* see technical data, limiting torque for overload M_G

Example: order number 1 / 400.614.0 / 20 / 6885-1 plus limit switch 055.000.5

Short supported hub

Type 400._14.5

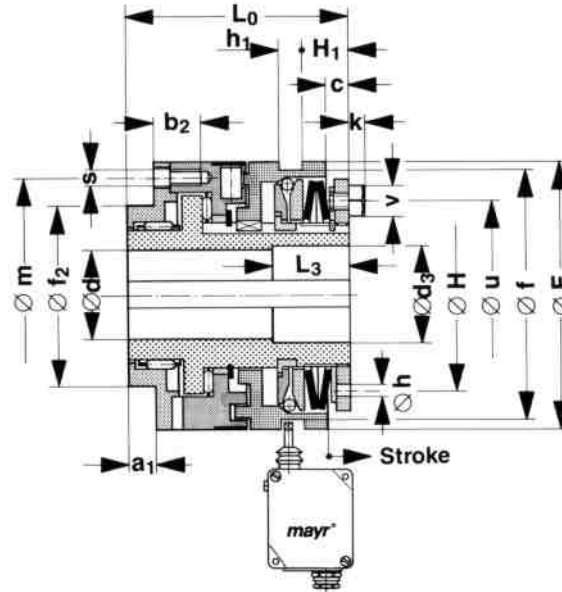

sizes 0-5 Type 400._14.5

Technical data

size	Limiting torques for overload M_G			Max. speed n_{max} rpm	Weight pilot bored kg	Stroke of the control element in the event of an overload mm	Mass moments of inertia	
	Type 400.414.5 Nm	Type 400.514.5 Nm	Type 400.614.5 Nm				Pressure flange side kgm ²	Hub side kgm ²
0	5 - 10	10 - 20	20 - 40	6000	0,7	2,2 -0,6	0,00012	0,00011
1	12 - 25	25 - 50	50 - 100	5000	2	3 -0,7	0,00091	0,00070
2	25 - 50	50 - 100	100 - 200	4000	3	4 -1	0,00182	0,00205
3	50 - 100	100 - 200	200 - 400	3500	6	5 -1,5	0,00484	0,00541
4	100 - 200	200 - 400	400 - 800	3000	12	5 -1,2	0,01429	0,01711
5	175 - 350	350 - 700	700 - 1400	2300	20	6 -1,5	0,03095	0,04281

Table of dimensions

size	a_1	b_2	c	d_{min}	d_{max}	d_3	F	f	f_2 h6	H
0	8	11	5,5	8	20 ¹⁾	21	55	50	38	37
1	10	16,5	7	11	25 ²⁾	26	82	72	50	50
2	12	15	7	15	35	36	100	90	60	67
3	12	20	10	19	45	46	120	112	80	84
4	16	23,5	11	25	55	56	146	140	100	104
5	18	28,5	12	30	65	66	176	170	120	125

size	H_1	h	h_1	k	L_0	L_3	m	s	u	v
0	7,5	3	9	- ³⁾	51	15	48	6 × M5	37	2 ³⁾
1	12	5	9	1,3 ³⁾	70	20	70	6 × M5	50	3 ³⁾
2	14	6	9	3	78	25	89	6 × M6	67	10
3	21	6	9	5,5	96	30	105	6 × M8	84	13
4	27	7	9	5,5	124	30	125	6 × M10	97	13
5	33	8	9	5,5	140	30	155	6 × M12	109	13

1) above \varnothing 16 keyway to DIN 6885/3

2) above \varnothing 22 keyway to DIN 6885/3

3) hexagon socket countersunk head cap screw to DIN 7991

We reserve the right to make dimensional and design alterations.

Order example:

To be included when ordering, please state:	size	Type	bore \varnothing d ^{H7}	keyway to DIN	with limit switch
Order number:		400._14.5			see page 58

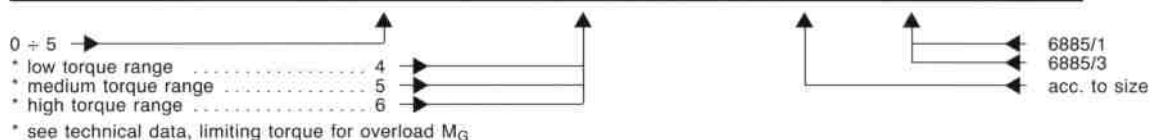

Example: order number 2 / 400.414.5 / 25 / 6885-1 plus limit switch 055.000.5

Long projecting hub

Type 400. _ 14.1

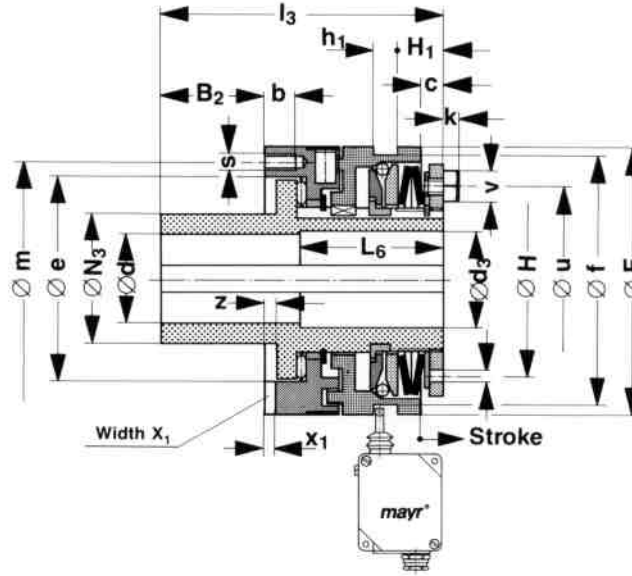

sizes 0-5 Type 400. _ 14.1

Technical data

size	Limiting torques for overload M_G			Max. speed n_{max} rpm	Weight pilot bored kg	Stroke of the control element in the event of an overload mm	Mass moments of inertia	
	Type 400.414.1 Nm	Type 400.514.1 Nm	Type 400.614.1 Nm				Pressure flange side kgm ²	Hub side kgm ²
0	5 - 10	10 - 20	20 - 40	6000	0,65	2,2 -0,6	0,00009	0,00011
1	12 - 25	25 - 50	50 - 100	5000	1,8	3 -0,7	0,00062	0,00072
2	25 - 50	50 - 100	100 - 200	4000	3,4	4 -1	0,00144	0,00214
3	50 - 100	100 - 200	200 - 400	3500	6	5 -1,5	0,00381	0,00570
4	100 - 200	200 - 400	400 - 800	3000	12	5 -1,2	0,00998	0,01769
5	175 - 350	350 - 700	700 - 1400	2300	19	6 -1,5	0,02345	0,04393

Table of dimensions

size	B_2	b	c	d_{min}	d_{max}	d_3	e	F	f	H	H_1	h
0	27,5	6,5	5,5	8	20 ¹⁾	21	41	55	50	37	7,5	3
1	33	8	7	11	25 ²⁾	26	60	82	72	50	12	5
2	39	10	7	15	35	36	78	100	90	67	14	6
3	47	12	10	19	45	46	90,5	120	112	84	21	6
4	52,5	16	11	25	55	56	105	146	140	104	27	7
5	57,5	17	12	30	65	66	120,5	176	170	125	33	8

size	h_1	k	L_6	l_3	m	$N_{3/17}$	s	u	v	X_1^{P9}	x_1	z
0	9	-	25	66	48	28	6 x M5	37	2 ³⁾	6	3,1	4
1	9	1,3 ³⁾	35	85	70	38	6 x M5	50	3 ³⁾	6	3,1	4
2	9	3,0	45	100	89	52	6 x M6	67	10	8	3,6	5
3	9	5,5	60	125	105	65	6 x M8	84	13	10	4,1	5
4	9	5,5	60	152	125	78	6 x M10	97	13	12	4,1	6,5
5	9	5,5	60	171	155	90	6 x M12	109	13	14	4,6	6,5

1) above \varnothing 16 keyway to DIN 6885/3

2) above \varnothing 22 keyway to DIN 6885/3

3) hexagon socket countersunk head cap screw to DIN 7991

We reserve the right to make dimensional and design alterations.

Order example:

To be included when ordering, please state:	size	Type	bore \varnothing dH7	keyway to DIN	with limit switch
Order number:		400. _ 14.1			see page 58

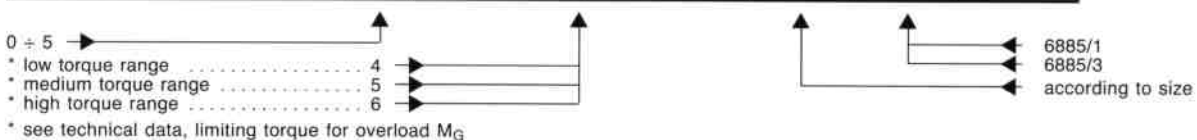

Example: order number 3 / 400.514.1 / 40 / 6885-1 plus limit switch 055.000.5

Lastic

Type 437. _ 14.0

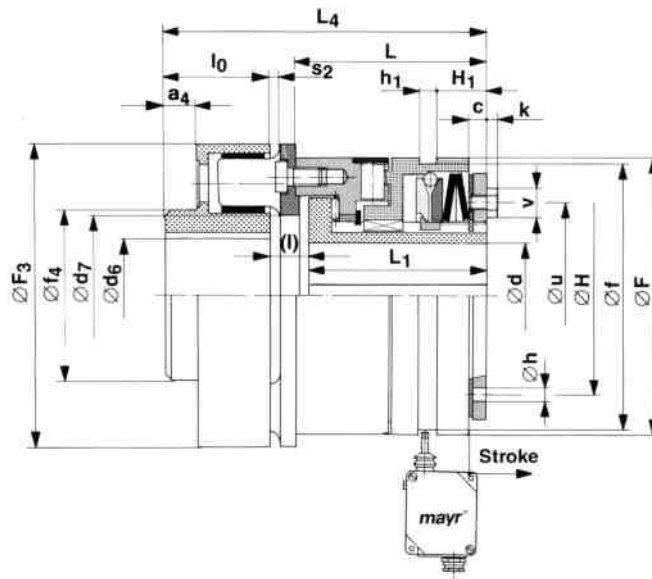

sizes 0–5 Type 437. _ 14.0

Technical data

size	Limiting torques for overload M_G			Max. speed n_{max} rpm	Rated torque of flexible coupling T_{KN} 4)	Weight pilot bored kg	Stroke of the control element in the event of an overload mm	Mass moments of inertia	
	Type 437.414.0 Nm	Type 437.514.0 Nm	Type 437.614.0 Nm					Flexible side kgm ²	Hub side kgm ²
0	5 – 10	10 – 20	20 – 40	6000	75	1,5	2,2 – 0,6	0,00081	0,00010
1	12 – 25	25 – 50	50 – 100	5000	150	3,8	3,0 – 0,7	0,00370	0,00067
2	25 – 50	50 – 100	100 – 200	4000	150	4,8	4,0 – 1	0,00441	0,00190
3	50 – 100	100 – 200	200 – 400	3500	300	9,2	5,0 – 1,5	0,01233	0,00517
4	100 – 200	200 – 400	400 – 800	3000	600	14,8	5,0 – 1,2	0,02568	0,01631
5	175 – 350	350 – 700	700 – 1400	2300	1200	27,0	6,0 – 1,5	0,06765	0,04162

Table of dimensions

size	a_4	c	d_{min}	d_{max}	d_6_{min}	d_6_{max}	d_7	F	F_3	f	f_4	H
0	7	5,5	8	20 1)	11	30	35	55	80	50	50	37
1	10	7	11	25 2)	11	42	50	82	105	72	65	50
2	10	7	15	35	11	42	65	100	105	90	65	67
3	19	10	19	45	13	60	80	120	135	112	85	84
4	17	11	25	55	25	60	88	146	160	140	90	104
5	35	12	30	65	30	75	110	176	198	170	115	125

size	H_1	h	h_1	k	L	L_1	L_4	l	l_0	s_2	u	v
0	7,5	3	9	– 3)	38,5	34,5	89,5	25	30	4	37	2 3)
1	12	5	9	1,3 3)	52	48	116	26	42	4	50	3 3)
2	14	6	9	3,0	61	56	125	27	42	4	67	10
3	21	6	9	5,5	78	73	159	31	55	4	84	13
4	27	7	9	5,5	99,5	93	168,5	20,5	55	6	97	13
5	33	8	9	5,5	113,5	107	211,5	22,5	82	6	109	13

1) above \varnothing 16 keyway to DIN 6885/3
2) above \varnothing 22 keyway to DIN 6885/3

3) hexagon socket countersunk head cap screw to DIN 7991
4) $T_{K max} = 3,0 \times T_{KN}$

We reserve the right to make dimensional and design alterations.

Order example:

To be included when ordering, please state:	size	Type	bore $\varnothing d_{H7}$	keyway to DIN	bore $\varnothing d_6_{H7}$	keyway to DIN	with limit switch
Order number:		437. _ 14.0					see page 58



Example: order number 3 / 437.514.0 / 35 / 6885-1 / 50 / 6885-1 plus limit switch 055.000.5

EAS[®]-standard synchronous overload clutch

The overload mechanism

- * In the event of an overload the control element moves axially.
- * Due to the axial force the switching elements are moved axially inwards by the control element.
- * The control element remains in its disengaged position.

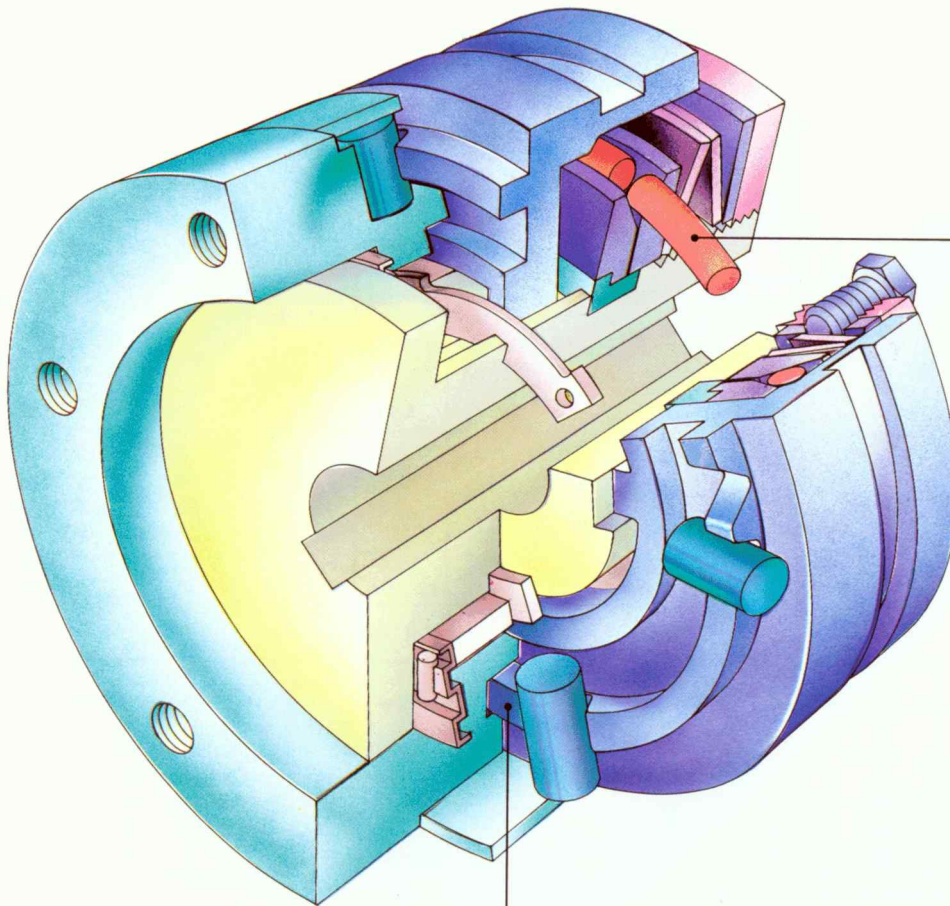
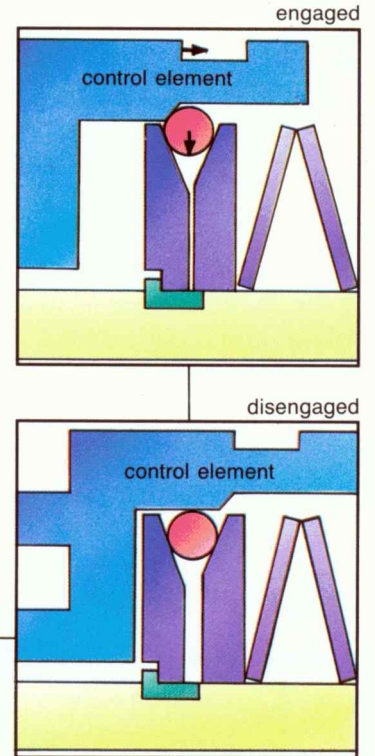

The load disconnecting synchronous safety clutch

- * Re-engagement is always guaranteed at specific positions due to the special mayr-synchronous geometry and mayr-precision rollers and components.

Operating principle of the EAS[®]-synchronous overload clutch

- * The clutch becomes free when the set limiting torque is achieved.
- * In the event of an overload input and output become disconnected due to the overload mechanism. After acting gyrating masses, e.g. drum, can coast freely.
- * After removal of the overload EAS[®]-synchronous overload clutch can be re-engaged at 360° (at the same disengagement position). Alternative re-engaging positions of 45°, 60°, 120° or 180° are also available.
- * Re-engagement is effected manually or by equipping the clutch with an automatic reset device.

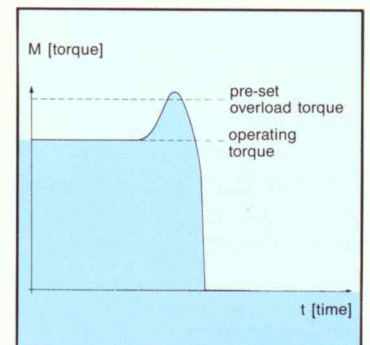
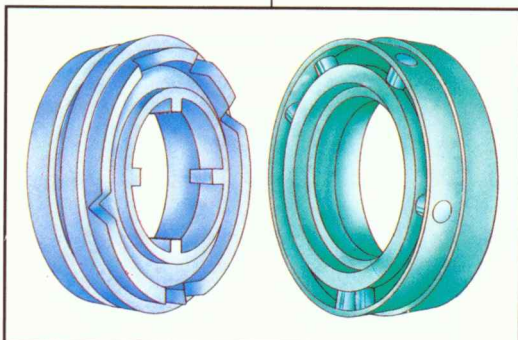

Switching behaviour

Summary of types

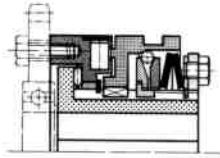
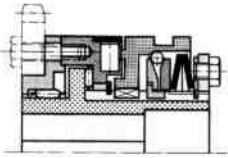
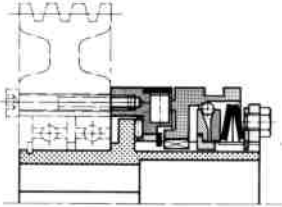
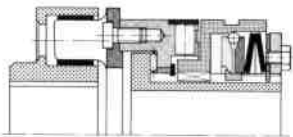
EAS [®] -clutch	Type	Torque (Nm)	Application
EAS[®]-flanged version 	400._03.0	5 ÷ 1400	For fitting drive elements such as chain sprockets, gears, toothed belt pulleys, V-belt pulleys, etc. The drive element and bearing are customer supply.
			page 38
EAS[®]-short supported hub 	400._03.5	5 ÷ 1400	EAS [®] -clutch with fitted bearing to take single, symmetrical and narrow drive elements (chain sprocket, gear, single-groove V-belt pulley, etc). Provision of an additional bearing for the drive element by the customer becomes unnecessary. Clutch, which can easily be pushed on.
			page 39
EAS[®]-long projecting hub 	400._03.1	5 ÷ 1400	The bearing of the drive element can be carried out by the customer to suit his own application. Suitable for wide, projecting drive elements; ball bearing or bronze bushing possible. Compact design – very advantageous also for short shaft ends.
			page 40
EAS[®]-Lastic 	437._03.0	5 ÷ 1400	Torsionally flexible overload clutch for connecting two shafts. The flexible coupling element is designed as a simple push-on coupling, permitting easy fitting and removal of the clutch.
			page 41
Electrical accessories			Limit switch,
			pages 58 to 60

Flanged version

Type 400._03.0

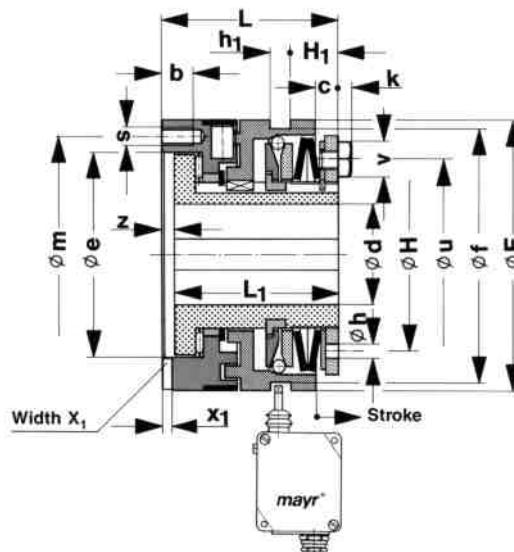

sizes 0-5 Type 400._03.0

Technical data

size	Limiting torques for overload M_G			Max. speed n_{max} rpm	Weight pilot bored kg	Stroke of the control element in the event of an overload mm	Mass moments of inertia	
	Type 400.403.0 Nm	Type 400.503.0 Nm	Type 400.603.0 Nm				Pressure flange side kgm ²	Hub side kgm ²
0	5 – 10	10 – 20	20 – 40	6000	0,5	1,6	0,00009	0,00010
1	12 – 25	25 – 50	50 – 100	5000	1,5	2,3	0,00062	0,00067
2	25 – 50	50 – 100	100 – 200	4000	2,7	3,0	0,00149	0,00190
3	50 – 100	100 – 200	200 – 400	3500	4,7	3,5	0,00380	0,00517
4	100 – 200	200 – 400	400 – 800	3000	9,8	3,8	0,00998	0,01631
5	175 – 350	350 – 700	700 – 1400	2300	16,0	4,5	0,02345	0,04162

Table of dimensions

size	b	c	d_{min}	d_{max}	e	F	f	H	H_1	h	h_1
0	6,5	5,5	8	20 ¹⁾	41	55	50	37	7,5	3	9
1	8	7	11	25 ²⁾	60	82	72	50	12	5	9
2	10	7	15	35	78	100	90	67	14	6	9
3	12	10	19	45	90,5	120	112	84	21	6	9
4	16	11	25	55	105	146	140	104	27	7	9
5	17	12	30	65	120,5	176	170	125	33	8	9

size	k	L	L_1	m	s	u	v	X_1^{P9}	x_1	z
0	– ³⁾	38,5	34,5	48	6 × M5	37	2 ³⁾	6	3,1	4
1	1,3 ³⁾	52	48	70	6 × M5	50	3 ³⁾	6	3,1	4
2	3,0	61	56	89	6 × M6	67	10	8	3,6	5
3	5,5	78	73	105	6 × M8	84	13	10	4,1	5
4	5,5	99,5	93	125	6 × M10	97	13	12	4,1	6,5
5	5,5	113,5	107	155	6 × M12	109	13	14	4,6	6,5

1) above \varnothing 16 keyway to DIN 6885/3

2) above \varnothing 22 keyway to DIN 6885/3

3) hexagon socket countersunk head cap screw to DIN 7991

We reserve the right to make dimensional and design alterations.

Order example:

To be included when ordering, please state:	size	Type	bore $\varnothing d^{H7}$	keyway to DIN	with limit switch
Order number:		400._03.0			see page 58

0 ÷ 5 →
 * low torque range 4 →
 * medium torque range 5 →
 * high torque range 6 →
 * see technical data, limiting torque for overload M_G

6885/1
6885/3
according to size

Example: order number 1 / 400.603.0 / 20 / 6885-1 plus limit switch 055.000.5

Short supported hub

Type 400._03.5

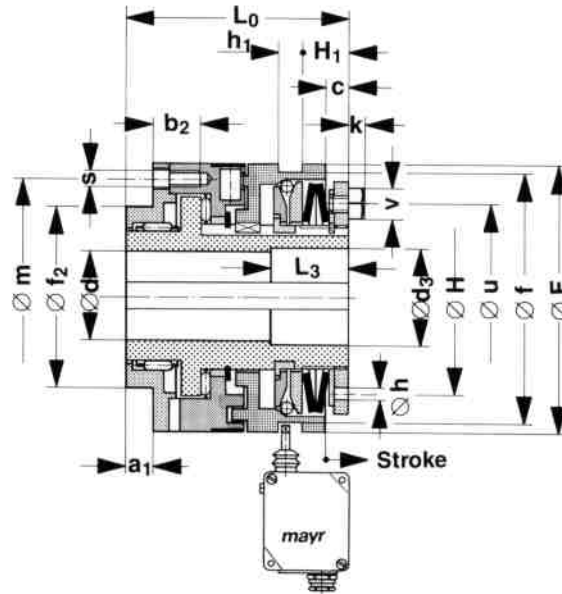

sizes 0-5 Type 400._03.5

Technical data

size	Limiting torques for overload M_G			Max. speed n_{max} rpm	Weight pilot bored kg	Stroke of the control element in the event of an overload mm	Mass moments of inertia	
	Type 400.403.5 Nm	Type 400.503.5 Nm	Type 400.603.5 Nm				Pressure flange side kgm ²	Hub side kgm ²
0	5 – 10	10 – 20	20 – 40	6000	0,7	1,6	0,00012	0,00011
1	12 – 25	25 – 50	50 – 100	5000	2	2,3	0,00091	0,00070
2	25 – 50	50 – 100	100 – 200	4000	3	3,0	0,00182	0,00205
3	50 – 100	100 – 200	200 – 400	3500	6	3,5	0,00484	0,00541
4	100 – 200	200 – 400	400 – 800	3000	12	3,8	0,01429	0,01711
5	175 – 350	350 – 700	700 – 1400	2300	20	4,5	0,03095	0,04281

Table of dimensions

size	a_1	b_2	c	d_{min}	d_{max}	d_3	F	f	f_2 h6	H
0	8	11	5,5	8	20 ¹⁾	21	55	50	38	37
1	10	16,5	7	11	25 ²⁾	26	82	72	50	50
2	12	15	7	15	35	36	100	90	60	67
3	12	20	10	19	45	46	120	112	80	84
4	16	23,5	11	25	55	56	146	140	100	104
5	18	28,5	12	30	65	66	176	170	120	125

size	H_1	h	h_1	k	L_0	L_3	m	s	u	v
0	7,5	3	9	– ³⁾	51	15	48	6 × M5	37	2 ³⁾
1	12	5	9	1,3 ³⁾	70	20	70	6 × M5	50	3 ³⁾
2	14	6	9	3,0	78	25	89	6 × M6	67	10
3	21	6	9	5,5	96	30	105	6 × M8	84	13
4	27	7	9	5,5	124	30	125	6 × M10	97	13
5	33	8	9	5,5	140	30	155	6 × M12	109	13

1) above \varnothing 16 keyway to DIN 6885/3

2) above \varnothing 22 keyway to DIN 6885/3

3) hexagon socket countersunk head cap screw to DIN 7991

We reserve the right to make dimensional and design alterations.

Order example:

To be included when ordering, please state:	size	Type	bore \varnothing d ^{H7}	keyway to DIN	with limit switch
Order number:		400._03.5			see page 58

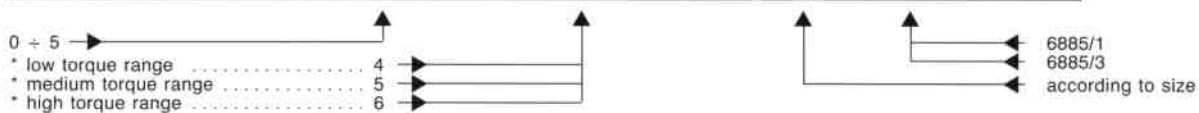

* see technical data, limiting torque for overload M_G

Example: order number 2 / 400.403.5 / 25 / 6885-1 plus limit switch 055.000.5

Long projecting hub

Type 400. _ 03.1

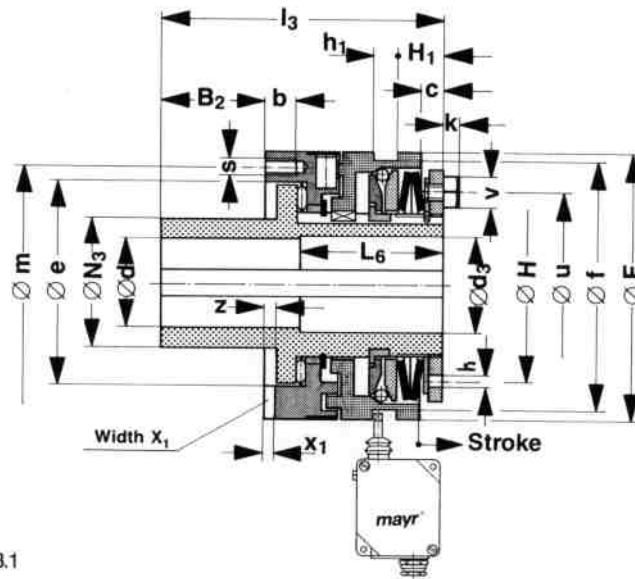

sizes 0-5 Type 400. _ 03.1

Technical data

size	Limiting torques for overload M_G			Max. speed n_{max} rpm	Weight pilot bored kg	Stroke of the control element in the event of an overload mm	Mass moments of inertia	
	Type 400.403.1 Nm	Type 400.503.1 Nm	Type 400.603.1 Nm				Pressure flange side kgm ²	Hub side kgm ²
0	5 – 10	10 – 20	20 – 40	6000	0,65	1,6	0,00009	0,00011
1	12 – 25	25 – 50	50 – 100	5000	1,8	2,3	0,00062	0,00072
2	25 – 50	50 – 100	100 – 200	4000	3,4	3,0	0,00144	0,00214
3	50 – 100	100 – 200	200 – 400	3500	6	3,5	0,00381	0,00570
4	100 – 200	200 – 400	400 – 800	3000	12	3,8	0,00998	0,01769
5	175 – 350	350 – 700	700 – 1400	2300	19	4,5	0,02345	0,04393

Table of dimensions

size	B_2	b	c	d_{min}	d_{max}	d_3	e	F	f	H	H_1	h
0	27,5	6,5	5,5	8	20 ¹⁾	21	41	55	50	37	7,5	3
1	33	8	7	11	25 ²⁾	26	60	82	72	50	12	5
2	39	10	7	15	35	36	78	100	90	67	14	6
3	47	12	10	19	45	46	90,5	120	112	84	21	6
4	52,5	16	11	25	55	56	105	146	140	104	27	7
5	57,5	17	12	30	65	66	120,5	176	170	125	33	8

size	h_1	k	L_6	l_3	m	N_3 f7	s	u	v	X_1^{P9}	x_1	z
0	9	– ³⁾	25	66	48	28	6 × M5	37	2 ³⁾	6	3,1	4
1	9	1,3 ³⁾	35	85	70	38	6 × M5	50	3 ³⁾	6	3,1	4
2	9	3,0	45	100	89	52	6 × M6	67	10	8	3,6	5
3	9	5,5	60	125	105	65	6 × M8	84	13	10	4,1	5
4	9	5,5	60	152	125	78	6 × M10	97	13	12	4,1	6,5
5	9	5,5	60	171	155	90	6 × M12	109	13	14	4,6	6,5

1) above \varnothing 16 keyway to DIN 6885/3

2) above \varnothing 22 keyway to DIN 6885/3

3) hexagon socket countersunk head cap screw to DIN 7991

We reserve the right to make dimensional and design alterations.

Order example:

To be included when ordering, please state:	size	Type	bore \varnothing d^{H7}	keyway to DIN	with limit switch
Order number:		400. _ 03. 1			see page 58

0 ÷ 5 →

- * low torque range 4
- * medium torque range 5
- * high torque range 6

* see technical data, limiting torque for overload M_G

Example: order number 3 / 400.503.1 / 40 / 6885-1 plus limit switch 055.000.5

6885/1
6885/3
according to size

Lastic

Type 437._03.0

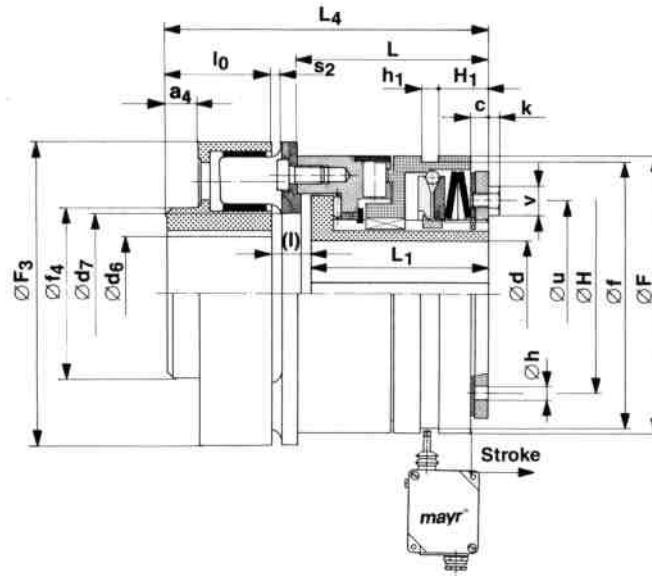

sizes 0-5 Type 437._03.0

Technical data

size	Limiting torques for overload M_G			Max. speed n_{max} rpm	Rated torque of flexible coupling T_{KN} 4)	Weight pilot bored kg	Stroke of the control element in the event of an overload mm	Mass moments of inertia	
	Type 437.403.0 Nm	Type 437.503.0 Nm	Type 437.603.0 Nm					Flexible side kgm ²	Hub side kgm ²
0	5 - 10	10 - 20	20 - 40	6000	75	1,5	1,6	0,00081	0,00010
1	12 - 25	25 - 50	50 - 100	5000	150	3,8	2,3	0,00370	0,00067
2	25 - 50	50 - 100	100 - 200	4000	150	4,8	3,0	0,00441	0,00190
3	50 - 100	100 - 200	200 - 400	3500	300	9,2	3,5	0,01233	0,00517
4	100 - 200	200 - 400	400 - 800	3000	600	14,8	3,8	0,02568	0,01631
5	175 - 350	350 - 700	700 - 1400	2300	1200	27,0	4,5	0,06765	0,04162

Table of dimensions

size	a_4	c	d_{min}	d_{max}	$d_{6 min}$	$d_{6 max}$	d_7	F	F_3	f	f_4	H
0	7	5,5	8	20 1)	11	30	35	55	80	50	50	37
1	10	7	11	25 2)	11	42	50	82	105	72	65	50
2	10	7	15	35	11	42	65	100	105	90	65	67
3	19	10	19	45	13	60	80	120	135	112	85	84
4	17	11	25	55	25	60	88	146	160	140	90	104
5	35	12	30	65	30	75	110	176	198	170	115	125

size	H_1	h	h_1	k	L	L_1	L_4	l	l_0	s_2	u	v
0	7,5	3	9	- 3)	38,5	34,5	89,5	25	30	4	37	2 3)
1	12	5	9	1,3 3)	52	48	116	26	42	4	50	3 3)
2	14	6	9	3,0	61	56	125	27	42	4	67	10
3	21	6	9	5,5	78	73	159	31	55	4	84	13
4	27	7	9	5,5	99,5	93	168,5	20,5	55	6	97	13
5	33	8	9	5,5	113,5	107	211,5	22,5	82	6	109	13

1) above \varnothing 16 keyway to DIN 6885/3
2) above \varnothing 22 keyway to DIN 6885/3

3) hexagon socket countersunk head cap screw to DIN 7991
4) $T_{K max} = 3,0 \times T_{KN}$

We reserve the right to make dimensional and design alterations.

Order example:

To be included when ordering, please state:	size	Type	bore $\varnothing d^{H7}$	keyway to DIN	bore $\varnothing d_6^{H7}$	keyway to DIN	with limit switch
Order number:		437._03.0					see page 58



Example: order number 3 / 437.503.0 / 35 / 6885-1 / 50 / 6885-1 plus limit switch 055.000.5

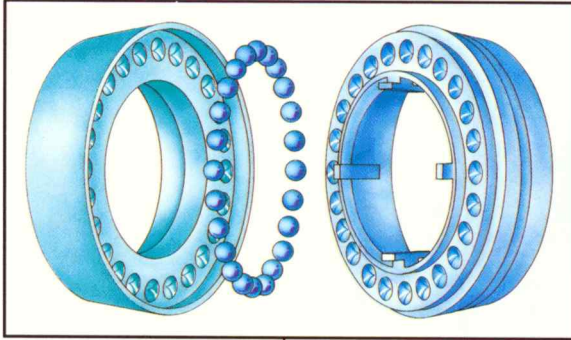

Operating principle of the EAS[®]-torque sensor clutch

- * When the pre-set limiting torque is achieved the mayr-limit switch provides an electrical signal, however, the torque transmission is not interrupted.

Function of the locking element:

- * Limits the axial stroke of the control element.
- * The mechanical disconnection of the input and output is, therefore, prevented.

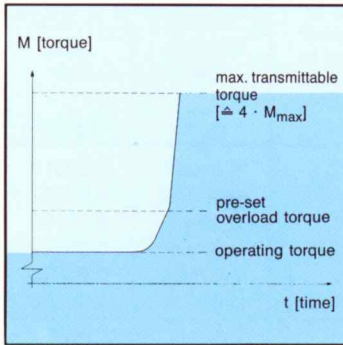

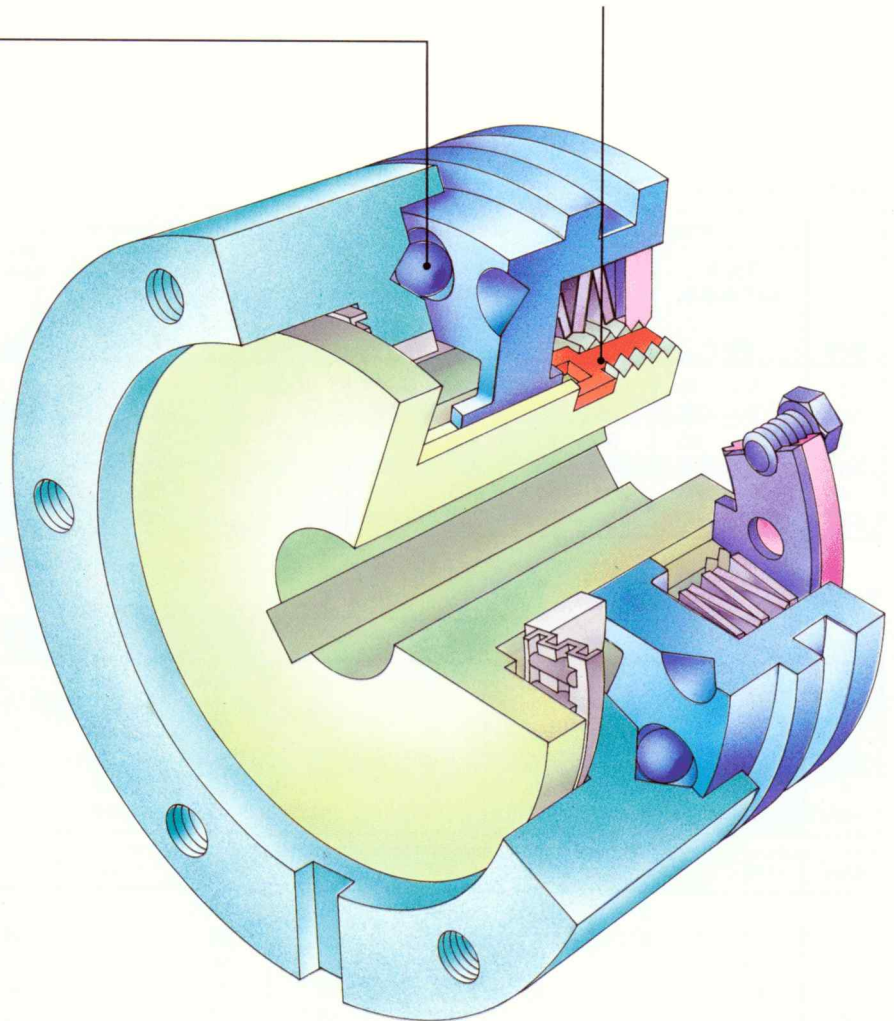

Switching behaviour



The load holding safety clutch

- * A maximum adjustment guarantees up to 4-times the load security (e.g. goods and personal lifts)

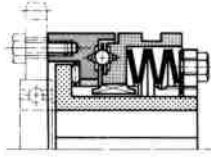
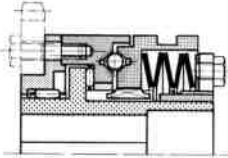
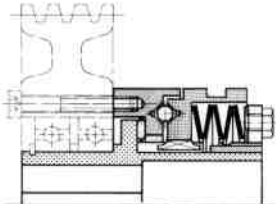
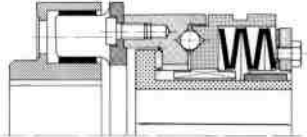
Summary of types

EAS [®] -clutch	Type	Torque (Nm)	Application
<p>EAS[®]-flanged version</p> 	400._01.0	5÷12000	<p>For fitting drive elements such as chain sprockets, gears, toothed belt pulleys, V-belt pulleys, etc. The drive element and bearing are customer supply.</p> <p>page 44</p>
<p>EAS[®]-short supported hub</p> 	400._01.5	5÷12000	<p>EAS[®]-clutch with fitted bearing to take single, symmetrical and narrow drive elements (chain sprocket, gear, single-groove V-belt pulley, etc.). Provision of an additional bearing for the drive element by the customer becomes unnecessary. Clutch, which can easily be pushed on.</p> <p>page 46</p>
<p>EAS[®]-long projecting hub</p> 	400._01.1	5÷12000	<p>The bearing of the drive element can be carried out by the customer to suit his own application. Suitable for wide, projecting drive elements; ball bearing or bronze bushing possible. Compact design – very advantageous also for short shaft ends.</p> <p>page 48</p>
<p>EAS[®]-Lastic</p> 	437._01.0	5÷1400	<p>Torsionally flexible overload clutch for connecting two shafts. The flexible coupling element is designed as a simple push-on coupling, permitting easy fitting and removal of the clutch.</p> <p>page 50</p>
<p>EAS[®]-positive</p> 	435._01.0	300÷6000	<p>Positive, torsionally flexible overload clutch for connecting two shafts. The flexible coupling section is designed as a torsionally flexible, resilient slip-on coupling. The coupling has axial, radial, angular and torsional resiliences.</p> <p>page 51</p>
<p>Electrical accessories</p>			<p>Limit switch</p> <p>pages 58 to 60</p>

Flanged version

Type 400._01.0

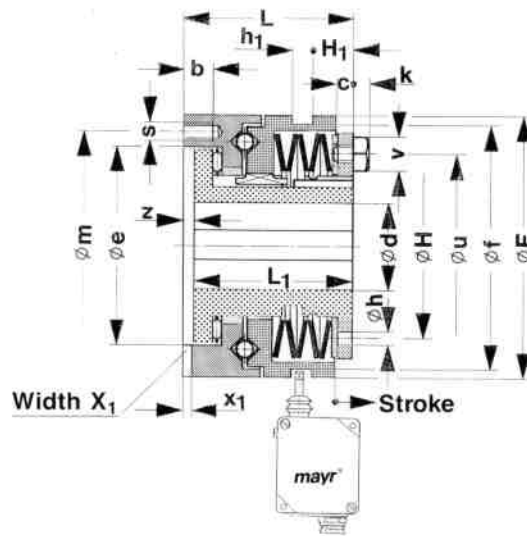

sizes 0-5 Type 400._01.0

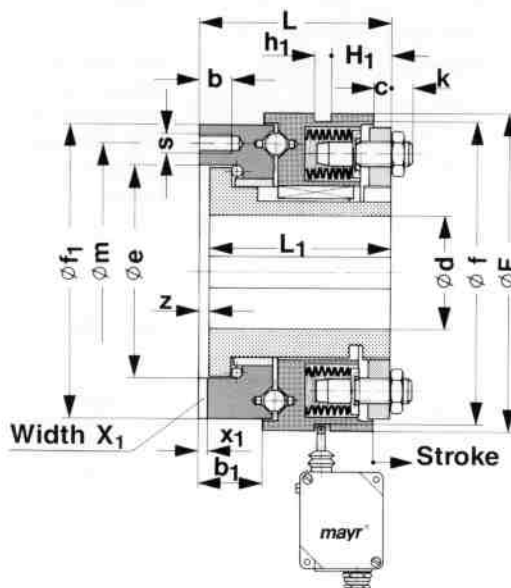

sizes 6-9 Type 400._01.0

Technical data

size	Limiting torques for overload M_G			Max. speeds		Weight pilot bored kg	Stroke of the control element in the event of an overload mm	Mass moments of inertia	
	Type 400.401.0	Type 400.501.0	Type 400.601.0	Type 400.401.0	Type 400.601.0			Pressure flange side kgm ²	Hub side kgm ²
	Nm	Nm	Nm	rpm	rpm				
0	5 - 10	10 - 20	20 - 40	6500	4300	0,5	1,5	0,00009	0,00010
1	12 - 25	25 - 50	50 - 100	4300	2900	1,5	2	0,00062	0,00067
2	25 - 50	50 - 100	100 - 200	3580	2400	2,7	2,5	0,00149	0,00190
3	50 - 100	100 - 200	200 - 400	3000	2000	4,7	2,5	0,00380	0,00517
4	100 - 200	200 - 400	400 - 800	2500	1600	9,8	3	0,00998	0,01631
5	175 - 350	350 - 700	700 - 1400	2050	1360	16	4	0,02345	0,04162
6	300 - 600	600 - 1200	1200 - 2400	1800	1200	21	4	0,03961	0,07689
7	500 - 1000	1000 - 2000	2000 - 4000	1470	980	37	4	0,09693	0,19679
8	850 - 1700	1700 - 3400	3400 - 6800	1250	830	63	5	0,23582	0,50111
9	1500 - 3000	3000 - 6000	6000 - 12000	920	616	126	5	0,83119	1,85006

Table of dimensions

size	b	b ₁	c	d _{min}	d _{max}	e	F	f	f ₁	H	H ₁	h
0	6,5	–	5,9	8	20 ¹⁾	41	55	50	–	37	8,4	3
1	8	–	7	11	25 ²⁾	60	82	72	–	50	12	5
2	10	–	7	15	35	78	100	90	–	67	14	6
3	12	–	10	19	45	90,5	120	112	–	84	21	6
4	16	–	11	25	55	105	146	140	–	104	27	7
5	17	–	12	30	65	120,5	176	170	–	125	33	8
6	19	40	11	40	75	136	200	190	186	–	38	–
7	22	43	15	50	100	168	240	230	227	–	46	–
8	26	52	18	60	120	198	285	275	266	–	53	–
9	36	59	21	70	150	265	380	370	358	–	75	–

size	h ₁	k	L	L ₁	m	s	u	v	X ₁ ^{P9}	x ₁	z
0	9	– ³⁾	38,5	34,5	48	6 × M5	37	2 ³⁾	6	3,1	4
1	9	1,3 ³⁾	52	48	70	6 × M5	50	3 ³⁾	6	3,1	4
2	9	3,0	61	56	89	6 × M6	67	10	8	3,6	5
3	9	5,5	78	73	105	6 × M8	84	13	10	4,1	5
4	9	5,5	99,5	93	125	6 × M10	97	13	12	4,1	6,5
5	9	5,5	113,5	107	155	6 × M12	109	13	14	4,6	6,5
6	9	16	119	112	160	6 × M12	–	24	16	5,1	7
7	9	15	141	133	200	6 × M16	–	30	18	5,6	8
8	9	12	172	164	230	6 × M20	–	30	20	6,1	8
9	9	14,5	190	180	315	6 × M24	–	36	20	6,1	10

1) above ∅ 16 keyway to DIN 6885/3

2) above ∅ 22 keyway to DIN 6885/3

3) hexagon socket countersunk head cap screw to DIN 7991

We reserve the right to make dimensional and design alterations.

Order example:

To be included when ordering, please state:	size	Type	bore ∅ d _{H7}	keyway to DIN	with limit switch
Order number:		400. _ 01.0			see page 58

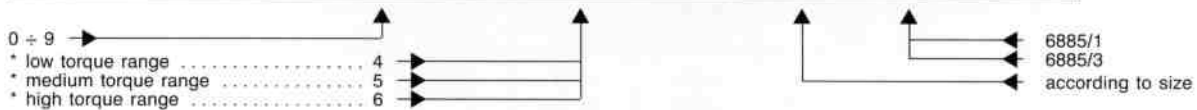

Example: order number 1 / 400.501.0 / 20 / 6885-1 plus limit switch 055.000.5

Short supported hub

Type 400._01.5

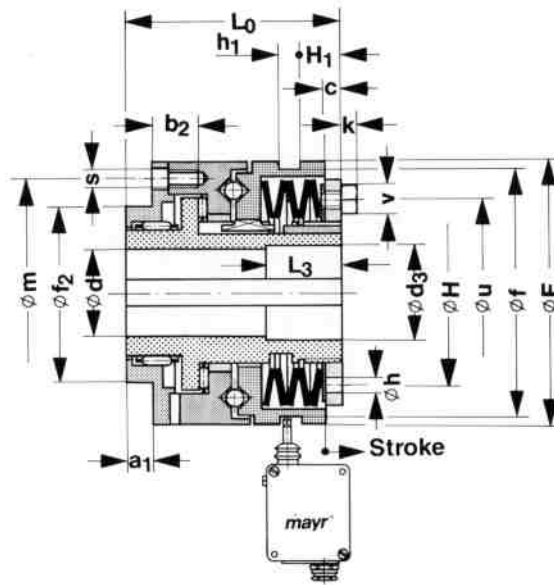

sizes 0-5 Type 400._01.5

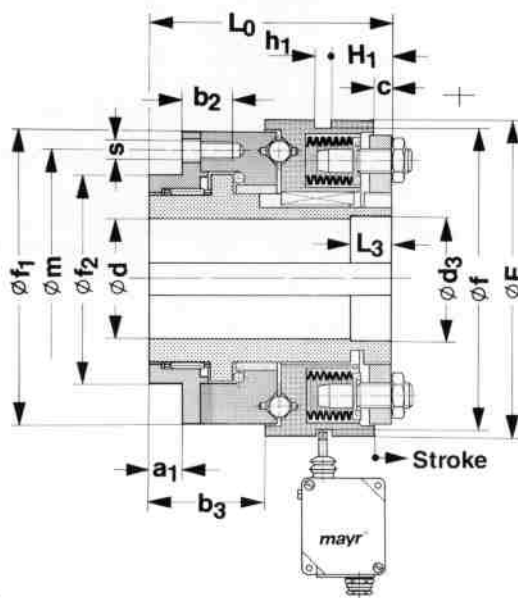

sizes 6-9 Type 400._01.5

Technical data

size	Limiting torques for overload M_G			Max. speeds		Weight pilot bored kg	Stroke of the control element in the event of an overload mm	Mass moments of inertia	
	Type 400.401.5	Type 400.501.5	Type 400.601.5	Type 400.401.5	Type 400.601.5			Pressure flange side kgm ²	Hub side kgm ²
	Nm	Nm	Nm	400.501.5 rpm	rpm				
0	5 - 10	10 - 20	20 - 40	6500	4300	0,7	1,5	0,00012	0,00011
1	12 - 25	25 - 50	50 - 100	4300	2900	2	2	0,00091	0,00070
2	25 - 50	50 - 100	100 - 200	3580	2400	3	2,5	0,00182	0,00205
3	50 - 100	100 - 200	200 - 400	3000	2000	6	2,5	0,00484	0,00541
4	100 - 200	200 - 400	400 - 800	2500	1600	12	3	0,01429	0,01711
5	175 - 350	350 - 700	700 - 1400	2050	1360	20	4	0,03095	0,04281
6	300 - 600	600 - 1200	1200 - 2400	1800	1200	26	4	0,05466	0,07886
7	500 - 1000	1000 - 2000	2000 - 4000	1470	980	44	4	0,12383	0,20268
8	850 - 1700	1700 - 3400	3400 - 6800	1250	830	78	5	0,33589	0,51380
9	1500 - 3000	3000 - 6000	6000 - 12000	920	616	155	5	1,14815	1,91707

Table of dimensions

size	a ₁	b ₂	b ₃	c	d _{min}	d _{max}	d ₃	F	f	f ₁	f ₂ h6
0	8	11	–	5,9	8	20 ¹⁾	21	55	50	–	38
1	10	16	–	7	11	25 ²⁾	26	82	72	–	50
2	12	15	–	7	15	35	36	100	90	–	60
3	12	18	–	10	19	45	46	120	112	–	80
4	16	23,5	–	11	25	55	56	146	140	–	100
5	18	25,5	–	12	30	65	66	176	170	–	120
6	20	30	71	11	40	75	76	200	190	186	130
7	25	31	77	15	50	100	101	240	230	227	160
8	30	44	100	18	52	120	121	285	275	266	190
9	32	54	109	21	70	150	151	380	370	358	250

size	H	H ₁	h	h ₁	k	L ₀	L ₃	m	s	u	v
0	37	8,4	3	9	– ³⁾	51	15	48	6 × M5	37	2 ³⁾
1	50	12	5	9	1,3 ³⁾	70	20	70	6 × M5	50	3 ³⁾
2	67	14	6	9	3,0	78	25	89	6 × M6	67	10
3	84	21	6	9	5,5	96	30	105	6 × M8	84	13
4	104	27	7	9	5,5	124	30	125	6 × M10	97	13
5	125	33	8	9	5,5	140	30	155	6 × M12	109	13
6	–	38	–	9	–	150	25	160	6 × M12	–	–
7	–	46	–	9	–	175	35	200	6 × M16	–	–
8	–	53	–	9	–	220	40	230	6 × M20	–	–
9	–	75	–	9	–	240	40	315	6 × M24	–	–

1) above ∅ 16 keyway to DIN 6885/3

2) above ∅ 22 keyway to DIN 6885/3

3) hexagon socket countersunk head cap screw to DIN 7991

We reserve the right to make dimensional and design alterations.

Order example:

To be included when ordering, please state:	size	Type	bore ∅ dH7	keyway to DIN	with limit switch
Order number:		400. _ 01.5			see page 58

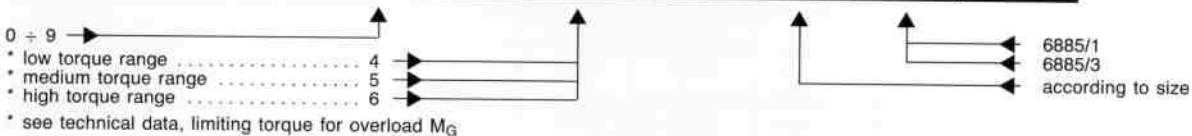

Example: order number 2 / 400.401.5 / 25 / 6885-1 plus limit switch 055.000.5

Long projecting hub

Type 400._01.1

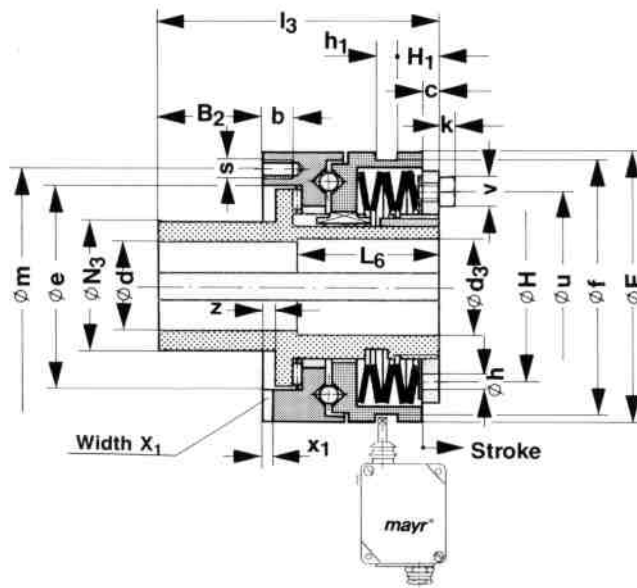

sizes 0-5 Type 400._01.1

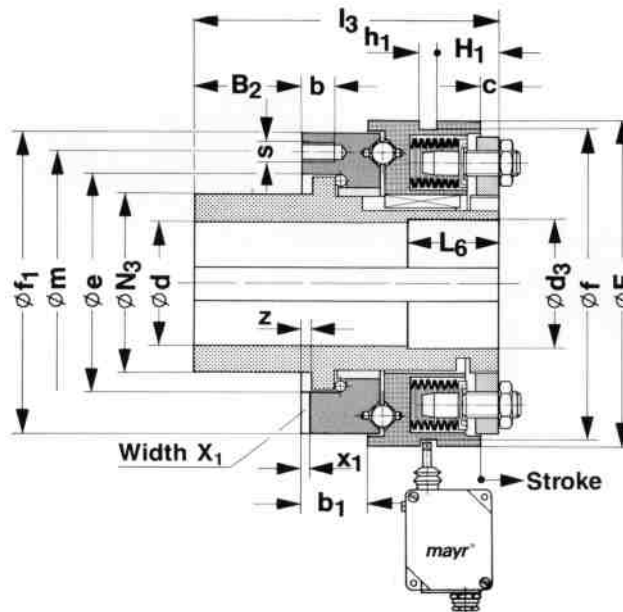

sizes 6-9 Type 400._01.1

Technical data

size	Limiting torques for overload Mg			Max. speeds		Weight pilot bored kg	Stroke of the control element in the event of an overload mm	Mass moments of inertia	
	Type 400.401.1 Nm	Type 400.501.1 Nm	Type 400.601.1 Nm	Type 400.401.1 400.501.1 rpm	Type 400.601.1 rpm			Pressure flange side kgm ²	Hub side kgm ²
0	5 – 10	10 – 20	20 – 40	6500	4300	0,65	1,5	0,00009	0,00011
1	12 – 25	25 – 50	50 – 100	4300	2900	1,8	2	0,00062	0,00072
2	25 – 50	50 – 100	100 – 200	3580	2400	3,4	2,5	0,00144	0,00214
3	50 – 100	100 – 200	200 – 400	3000	2000	6	2,5	0,00381	0,00570
4	100 – 200	200 – 400	400 – 800	2500	1600	12	3	0,00998	0,01769
5	175 – 350	350 – 700	700 – 1400	2050	1360	19	4	0,02345	0,04393
6	300 – 600	600 – 1200	1200 – 2400	1800	1200	25,5	4	0,03961	0,08253
7	500 – 1000	1000 – 2000	2000 – 4000	1470	980	45	4	0,09693	0,21088
8	850 – 1700	1700 – 3400	3400 – 6800	1250	830	75,5	5	0,23582	0,53181
9	1500 – 3000	3000 – 6000	6000 – 12000	920	616	158	5	0,83119	2,02663

Table of dimensions

size	B ₂	b	b ₁	c	d _{min}	d _{max}	d ₃	e	F	f	f ₁	H	H ₁
0	27,5	6,5	–	5,9	8	20 ¹⁾	21	41	55	50	–	37	8,4
1	33	8	–	7	11	25 ²⁾	26	60	82	72	–	50	12
2	39	10	–	7	15	35	36	78	100	90	–	67	14
3	47	12	–	10	19	45	46	90,5	120	112	–	84	21
4	52,5	16	–	11	25	55	56	105	146	140	–	104	27
5	57,5	17	–	12	30	65	66	120,5	176	170	–	125	33
6	64	19	40	11	40	75	76	136	200	190	186	–	38
7	72	22	43	15	50	100	101	168	240	230	227	–	46
8	82	26	52	18	52	120	121	198	285	275	266	–	53
9	102	36	59	21	70	150	151	265	380	370	358	–	75

size	h	h ₁	k	L ₆	l ₃	m	N _{3 17}	s	u	v	X ₁ ^{P9}	x ₁	z
0	3	9	– ³⁾	25	66	48	28	6 × M5	37	2 ³⁾	6	3,1	4
1	5	9	1,3 ³⁾	35	85	70	38	6 × M5	50	3 ³⁾	6	3,1	4
2	6	9	3,0	45	100	89	52	6 × M6	67	10	8	3,6	5
3	6	9	5,5	60	125	105	65	6 × M8	84	13	10	4,1	5
4	7	9	5,5	60	152	125	78	6 × M10	97	13	12	4,1	6,5
5	8	9	5,5	60	171	155	90	6 × M12	109	13	14	4,6	6,5
6	–	9	–	55	183	160	108	6 × M12	–	–	16	5,1	7
7	–	9	–	70	213	200	135	6 × M16	–	–	18	5,6	8
8	–	9	–	70	254	230	160	6 × M20	–	–	20	6,1	8
9	–	9	–	90	292	315	225	6 × M24	–	–	20	6,1	10

1) above ∅ 16 keyway to DIN 6885/3

2) above ∅ 22 keyway to DIN 6885/3

3) hexagon socket countersunk head cap screw to DIN 7991

We reserve the right to make dimensional and design alterations.

Order example:

To be included when ordering, please state:	size	Type	bore ∅ d ^{H7}	keyway to DIN	with limit switch
Order number:		400. _ 01.1			see page 58

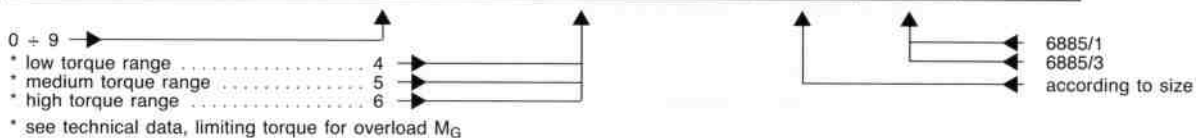

Example: order number 3 / 400.601.1 / 40 / 6885-1 plus limit switch 055.000.5

Lastic

Type 437._01.0

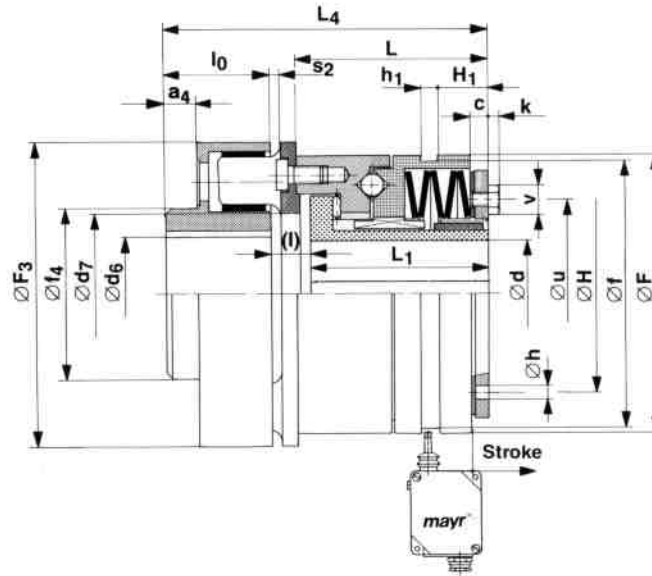

sizes 0-5 Type 437._01.0

Technical data

size	Limiting torques for overload M_G			Max. speeds		Rated torque of flexible coupling T_{KN} 4)	Weight pilot bored	Stroke of the control element in the event of an overload	Mass moments of inertia	
	Type 437.401.0	Type 437.501.0	Type 437.601.0	Type 437.401.0	Type 437.601.0				Flexible side	Hub side
	Nm	Nm	Nm	rpm	rpm	Nm	kg	mm	kgm ²	kgm ²
0	5 - 10	10 - 20	20 - 40	6500	4300	75	1,5	1,5	0,00081	0,00010
1	12 - 25	25 - 50	50 - 100	4300	2880	150	3,8	2,0	0,00370	0,00067
2	25 - 50	50 - 100	100 - 200	3580	2360	150	4,8	2,5	0,00441	0,00190
3	50 - 100	100 - 200	200 - 400	3000	2000	300	9,2	2,5	0,01233	0,00517
4	100 - 200	200 - 400	400 - 800	2500	1660	600	14,8	3,0	0,02568	0,01631
5	175 - 350	350 - 700	700 - 1400	2050	1360	1200	27,0	4,0	0,06765	0,04162

Table of dimensions

size	a ₄	c	d _{min}	d _{max}	d _{6 min}	d _{6 max}	d ₇	F	F ₃	f	f ₄	H
0	7	5,9	8	20 1)	11	30	35	55	80	50	50	37
1	10	7	11	25 2)	11	42	50	82	105	72	65	50
2	10	7	15	35	11	42	65	100	105	90	65	67
3	19	10	19	45	13	60	80	120	135	112	85	84
4	17	11	25	55	25	60	88	146	160	140	90	104
5	35	12	30	65	30	75	110	176	198	170	115	125

size	H ₁	h	h ₁	k	L	L ₁	L ₄	l	l ₀	s ₂	u	v
0	8,4	3	9	- 3)	38,5	34,5	89,5	25	30	4	37	2 3)
1	12	5	9	1,3 3)	52	48	116	26	42	4	50	3 3)
2	14	6	9	3,0	61	56	125	27	42	4	67	10
3	21	6	9	5,5	78	73	159	31	55	4	84	13
4	27	7	9	5,5	99,5	93	168,5	20,5	55	6	97	13
5	33	8	9	5,5	113,5	107	211,5	22,5	82	6	109	13

1) above \varnothing 16 keyway to DIN 6885/3
 2) above \varnothing 22 keyway to DIN 6885/3
 3) hexagon socket countersunk head cap screw to DIN 7991
 4) $T_{K max} = 3,0 \times T_{KN}$

We reserve the right to make dimensional and design alterations.

Order example:

To be included when ordering, please state:	size	Type	bore \varnothing d ^{H7}	keyway to DIN	bore \varnothing d ₆ ^{H7}	keyway to DIN	with limit switch
Order number:		437._01.0					see page 58



Example: order number 3 / 437.501.0 / 35 / 6885-1 / 50 / 6885-1 plus limit switch 055.000.5

Positive

Type 435._01.0

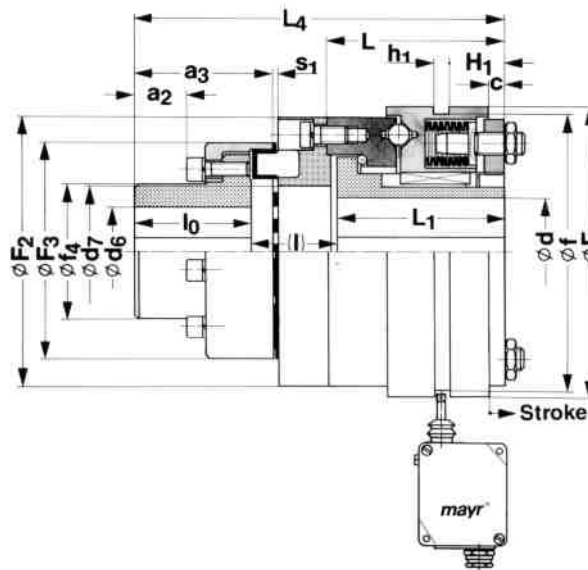

sizes 6-9 Type 435._01.0

Technical data

size	Limiting torques for overload M_G		Max. speeds	Weight pilot bored	Rated torque of positive flexible coupling T_{KN}^1	Stroke of the control element in the event of an overload	Mass moments of inertia	
	Type 435.401.0	Type 435.501.0	Type 435.401.0 435.501.0				Flexible side	Hub side
	Nm	Nm	rpm	kg	Nm	mm	kgm ²	kgm ²
6	300 – 600	600 – 800	1800	33,3	417	4	0,07993	0,07687
7	500 – 1000	1000 – 2000	1470	63,9	1120	4	0,25204	0,19676
8	850 – 1700	1700 – 3400	1250	99,7	1670	5	0,51589	0,50121
9	1500 – 3000	3000 – 6000	920	209,0	5550	5	1,96661	1,84999

Table of dimensions

size	a_2	a_3	c	d_{min}	d_{max}	$d_6 min$	$d_6 max$	d_7	F	F_2	F_3
6	36	92,5	11	40	75	-	60	90	200	186	148
7	49	117,5	15	50	100	-	75	115	240	240	194
8	53,4	129	18	60	120	-	85	130	285	270	214
9	80,8	176	21	70	150	58	115	170	380	360	295

size	f	f_4	H_1	h_1	L	L_1	L_4	l_0	l	s_1
6	190	92,5	38	9	119	112	249	78	59	$3,5 \pm 1$
7	230	121,5	46	9	141	133	307	97	77	$3,5 \pm 1,5$
8	275	135,5	53	9	172	164	357,5	107	86,5	$4,0 \pm 2$
9	370	181	75	9	190	180	437,5	147	110,5	$8,0 \pm 2,5$

1) $T_{K max} = 1,8 \times T_{KN}$

We reserve the right to make dimensional and design alterations.

Order example:

To be included when ordering, please state:	size	Type	bore $\varnothing d_{H7}$	keyway to DIN	bore $\varnothing d_6^{H7}$	keyway to DIN	with limit switch
Order number:		435._01.0					see page 58



Example: order number 7 / 435.501.0 / 80 / 6885-1 / 60 / 6885-1 plus limit switch 055.000.5

Operation in the drive line:

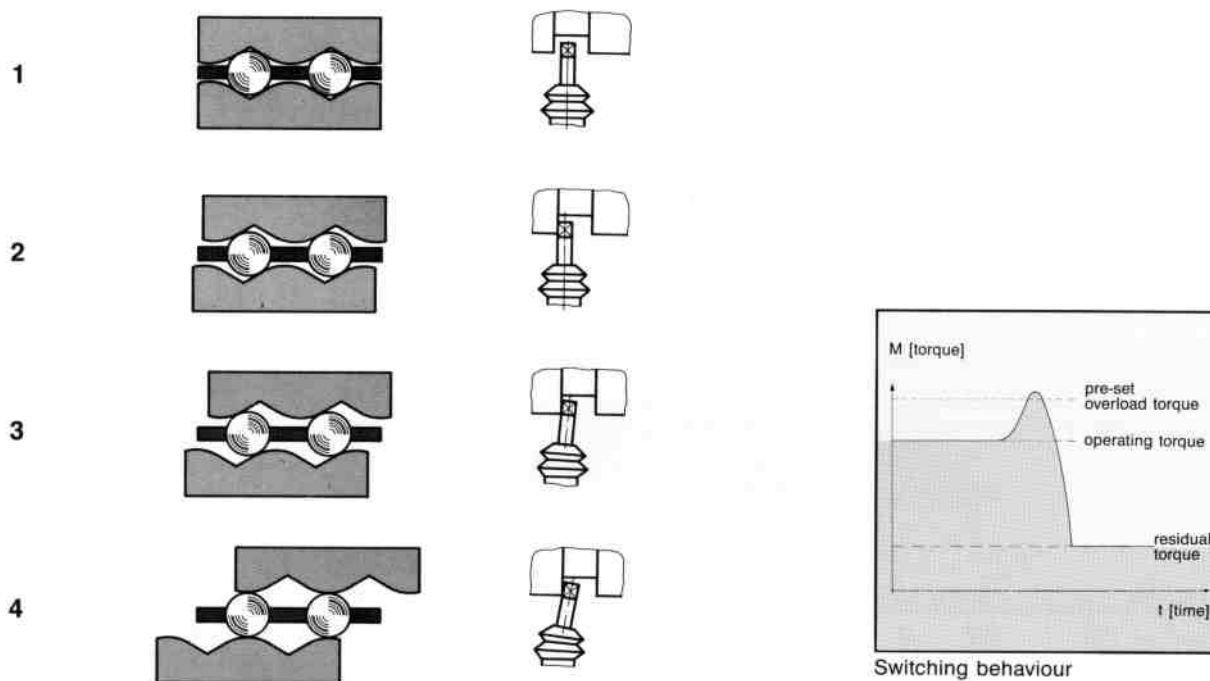

Fig. 1

1. EAS[®]-clutch engaged, operation with rated torque of the drive.
2. Torque in the drive shafting increases as a result of an overload, and the EAS[®]-clutch operates.
3. The control edge of the EAS[®]-clutch operates the limit switch (= electrical disconnecting torque), and the torque begins to drop at the same time.
4. The EAS[®]-clutch is fully disengaged.

The limiting torque for an overload set on the EAS[®]-clutch relates to the case of static or semi-static disengagement, i.e. disengagement up to moderate speeds and torque rise times. For high speeds and very short torque rise times (forceful, sudden locking), the disengaging torque on the EAS[®]-clutch can be increased by the dynamic torque component. This increase in the dynamic torque is dependent on the mass ratios and the stiffness of the drive shafting and varies in individual instances.

Particular attention must also be paid to the starting torques in the drive shafting. If the limiting torque set for an overload on the EAS[®]-clutch is below the maximum starting torque, the clutch disengages while starting and switches off the drive.

Control speed and accuracy

Depending on the distance of the limit switch from the control edge of the control element, contact is made after rotation of the pressure flange of approx. 1° or 2° with reference to the control element. This results in a switch-off contact after approx. 2–3 msec at 100 rpm and full locking.

Performance in service

EAS[®]-torque sensor clutch

It has to be noticed that the operating torque is decreased after overload has occurred or a starting bridge has been made so that the control element automatically returns to its initial position (hysteresis). A resonance of the control element can cause an increased wear.

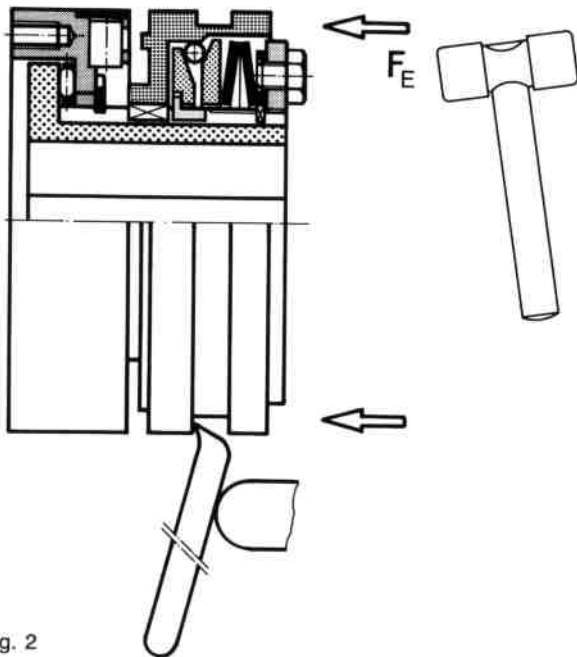

Fig. 2

Re-engagement

EAS[®]-overload clutch

The EAS[®]-synchronous overload clutch can only be engaged at the position where it has been disengaged. The clutch has to be turned to the correct angular position before it can be engaged. The re-engagement position can be recognised by marking holes at the outer diameter of the pressure flange and control element.

The EAS[®]-overload clutch can be re-engaged at any position (if necessary, a slight relative rotation between control element and pressure flange is necessary).

The EAS[®]-overload clutch (sizes 1-5) is re-engaged simply by exerting axial pressure on the control element of the clutch (figure 2).

Depending on the existing facilities, accessibility of the installation point etc., re-engagement can be effected in different ways:

- by means of a few taps with a plastic mallet on the edge of the control element
- with assembly levers
- with an engaging device. The engaging operation can also be automated with the aid of pneumatic or hydraulic cylinders.

The level of the re-engaging force F_E depends on the limiting torque set for an overload:

$$F_E = k \cdot M_G \text{ [N]}$$

F_E = re-engagement force [N]

k = 3,5 for all sizes
(calculation factor [$\frac{1}{m}$])

M_G = limiting torque set for an overload [Nm]

Maintenance

EAS[®]-clutches have a grease filling and are, therefore, lubricated for life. At specific intervals, the axial play of the shaft carrying the clutch should be checked. The clutch can become axially displaced due to excessive bearing play. This means a change in the switching distance, resulting in a different disengaging torque.

Otherwise, the EAS[®]-clutch does not require any maintenance at all. Special maintenance work may become necessary only where there is a considerable amount of dust and dirt or under extreme ambient conditions. In case, we request that you contact the works.

Types

Short supported hub (Type 4 ___ . ___ .5):

EAS[®]-clutches with a short supported hub are suitable for drives for which either the shaft ends are too short to take a clutch and drive element or the drive elements cannot be located on the shaft. The drive element merely needs to be centred ($\varnothing f_2$) and screwed on.

Long projecting hub (Type 4 ___ . ___ .1):

EAS[®]-clutch with a long projecting hub, like the version with a short supported hub, are suitable for drives for which either the shaft ends are too short to take a clutch and drive element or the drive elements cannot be located on the shaft. This version offers various possibilities for bearing the drive element (Ball bearing, needle bearing, plain bearing, etc.) which can be undertaken by the user himself.

EAS[®]-torsionally rigid coupling (Type 436. ___ .8):

EAS[®]-clutch, combined with a torsionally rigid flexible all-steel coupling for connecting 2 shafts. The torsionally rigid flexible coupling section is made up of the individual components of the ROBA[®]-D all-steel coupling.

The possible misalignments of the flexible coupling section, as given in table 7, represent general reference values which may be considered appropriate with a view to obtaining the longest possible service life for the coupling and shaft bearings.

For the exact design of the torsionally rigid flexible all-steel coupling ROBA[®]-D, especially the calculation of vibrations and starting impacts, see catalogue ROBA[®]-D.

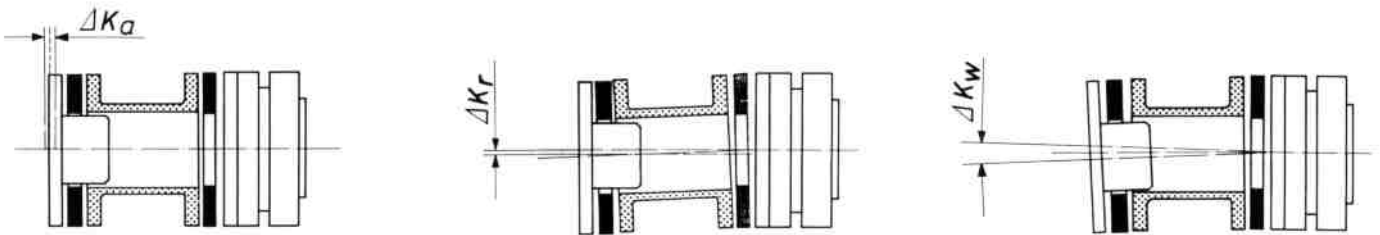

Fig. 14

EAS [®] size			0	1	2	3	4	5	6	7	8
Axial misalignment	Δ Ka	[mm]	0,8	1,0	1,2	1,4	1,6	1,8	1,8	2,0	2,2
Radial misalignment	Δ Kr	[mm]	1,0	1,25	1,5	1,8	2,1	2,2	2,5	2,5	3,0
Angular misalignment	Δ Kw	[°]	2	2	2	2	2	2	2	2	2

Table 7

Choice of sizes for EAS[®]-torsionally rigid coupling (Type 436. ___ .8):

$$M_{G \max} = \frac{T_{KN}}{f_A \cdot f_W} \text{ [Nm]}$$

$M_{G \max}$ = Maximum limiting torque to be set for an overload [Nm]
 T_{KN} = Rated torque of the torsionally rigid, flexible all-steel coupling [Nm] as per table of dimensions
 f_A = Service factor according to loading [-], fig. 15
 f_W = Service factor according to shaft misalignment [-], fig. 16

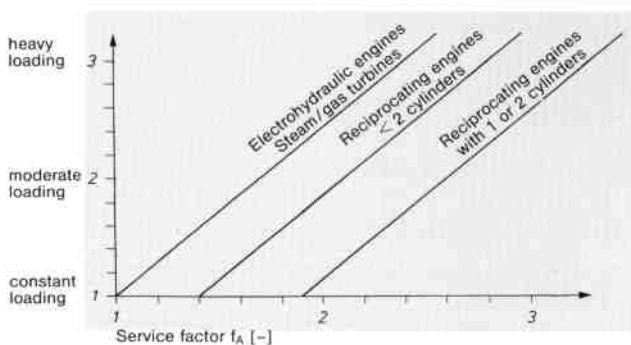

Fig. 15

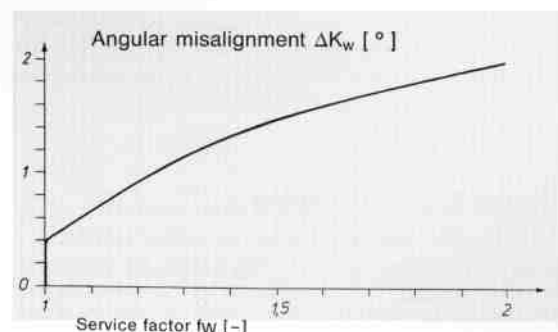

Fig. 16

EAS®-positive coupling (Type 435.____.0):

EAS®-clutch, combined with positive, flexible coupling section for connecting two shafts. The flexible coupling section is designed as a positive claw clutch. The torque is transmitted via a replaceable flexible intermediate ring in oil and heat-resistant material with a high damping capacity.

For sizes 1 to 5, the single-piece hub is used and, for sizes 6 to 9, the two-piece hub is used. In the case of the two-piece hub, the flexible intermediate ring can be replaced while the clutch is fitted. With this design, mechanical separation of the input and output is also possible. It is also possible for the input and output to be removed radially.

The possible misalignments of the flexible coupling section, as shown in table 8 below, represent general reference values which may be considered appropriate with a view to obtaining the longest possible service life for the clutch and shaft bearings.

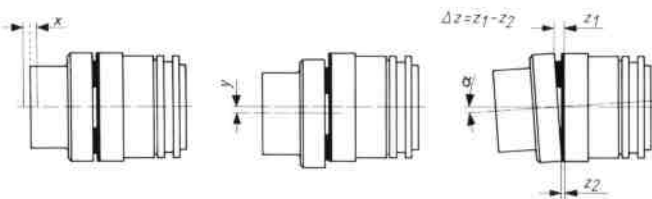

Fig. 17

size		6	7	8	9
x	[mm]	±1,0	±1,5	±2,0	±2,5
y	[mm]	0,6	0,7	0,7	0,8
α	[°]	0,23	0,24	0,21	0,16
Δz	[mm]	0,6	0,8	0,8	0,8

Table 8

Choice of sizes for EAS®-positive coupling: (Type 435.____.0):

$$M_{G \max} = \frac{1,8 \cdot T_{KN}}{k_1 \cdot k_2 \cdot k_3 \cdot k_4} \text{ [Nm]}$$

$M_{G \max}$ = Maximum limiting torque to be set for an overload [Nm]

T_{KN} = Rated torque of positive flexible coupling [Nm] as per table of dimensions

k_1 = Minimum safety factor for mode of operation [-]

k_2 = Minimum safety factor for period of operation [-]

k_3 = Minimum safety factor for starting frequency/engaging frequency [-]

k_4 = Minimum safety factor for ambient temperature [-]

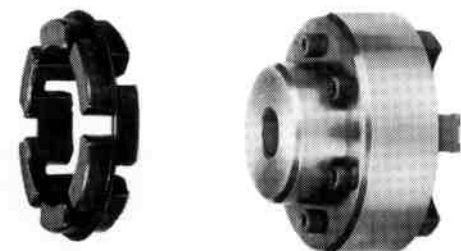

Flexible intermediate ring

Two-piece hub

Fig. 18

Driven machines		Factor k_1							
a) With constant running and negligible masses to be accelerated.		1							
b) With constant running and low masses to be accelerated.		1,2							
c) With uneven running and moderate masses to be accelerated.		1,4							
d) With uneven running, moderate masses to be accelerated and impacts.		1,7							
e) With uneven running, large masses to be accelerated and strong impacts.		2							
f) With uneven running, very large masses to be accelerated and particularly strong impacts		2,4							
Minimum safety factors k_3 for starting frequency/engagement frequency	Starts per hour	above up to	1	1	20	40	80	160	
			Factor k_3						
Mode of operation as per above table for factors k_1	a)		1	1,2	1,3	1,5	1,6	2	
	b)		1	1,09	1,18	1,37	1,46	1,8	
	c)		1	1,08	1,17	1,25	1,33	1,65	
	d)		1	1,07	1,15	1,23	1,23	1,55	
	e)		1	1,07	1,12	1,18	1,18	1,32	
	f)		1	1,06	1,08	1,1	1,1	1,1	
Minimum safety factors k_2 for period of operation	Daily running time				Minimum safety factors k_4 for ambient temperature				
	over up to	2	8	16					
		Factor k_2				20°	40°	60°	80°
		0,9	1	1,12	1,25	1	1,1	1,2	1,3

Table 9

EAS[®]-Lastic (Type 437.____.0):

EAS[®]-clutch, combined with a torsionally flexible coupling section for connecting two shafts. The torsionally flexible coupling section is designed as a simple push-on clutch. The torque is transmitted via flexible pressure rollers made from plastic resistant to wear, oil petrol and high temperatures.

The possible misalignments of the flexible coupling section which are given in table 1 below represent general reference values which may be considered appropriate with a view to obtaining the longest possible service life for the coupling and shaft bearing.

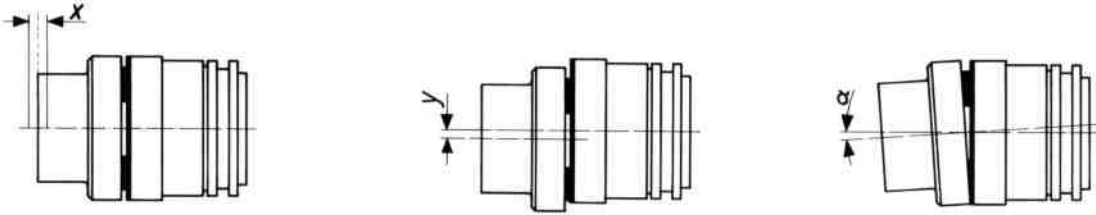

Fig. 12

size		0	1	2	3	4	5
Axial misalignment	x [mm]	±1	±1	±1	±1	±1	±1
Radial misalignment	y [mm]	0,5	0,5	0,5	0,5	0,5	0,5
Angular misalignment	α [°]	0,5	0,5	0,5	0,5	1	1

Table 1

Choice of sizes of EAS[®]-Lastic coupling (Type 437.____.0)

$$M_{G \max} = \frac{1,8 \cdot T_{KN}}{C} \text{ [Nm]}$$

$M_{G \max}$ = Maximum limiting torque to be set for an overload [Nm]
 T_{KN} = Rated torque of torsionally flexible coupling [Nm] as per table of dimensions
 C = Safety factor [-] as per table 2

Safety factors C

Drive machines / Types of operation	Electric motors Turbines	I. C. Engines 4–6 Cylindres Wasserturbines	I. C. Engines 1–3 Cylindres
1. Easy, smooth and even running	1	1,2	1,4
2. Even running and small masses to be accelerated	1,2	1,4	1,7
3. Uneven running and moderate masses to be accelerated	1,4	1,7	2
4. Uneven running, moderate masses to be accelerated and impacts	1,7	2	2,4
5. Uneven running, large masses to be accelerated and strong impacts	2	2,4	2,8
6. Uneven running, very large masses to be accelerated and particularly severe impacts	2,4	2,8	3,3

Table 2

Mounting examples:

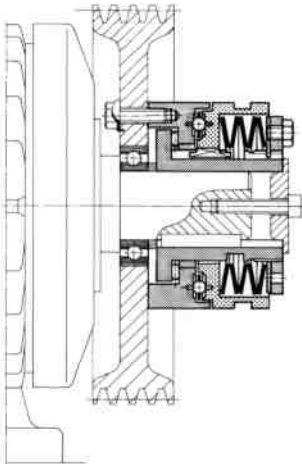

EAS[®] Type 400.600.0 with V-belt pulley

Often used mounting situation. EAS[®]-clutch mounted onto the shaft end of a motor. The V-belt pulley is supported via a deep groove ball bearing. The axial location of the clutch is made via a locking collar and set screw in the free shaft end.

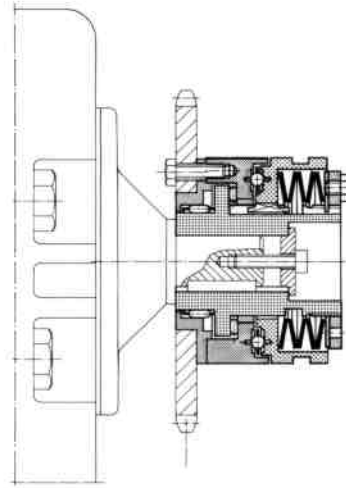

EAS[®] Type 400.600.5 with flanged sprocket

This design is ready to push on due to the integrated bearing. The axial location of the clutch is made via a locking collar and set screw in the free shaft end.

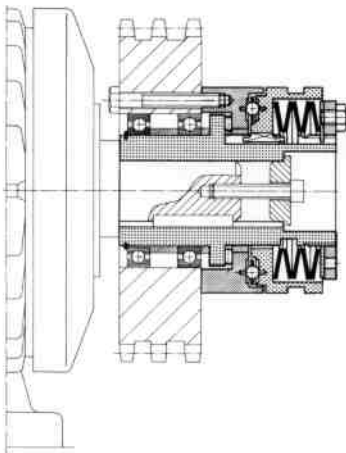

EAS[®] Type 400.600.1 with triplex chain sprocket

This clutch version is especially designed for wide drive elements. The triplex sprocket is supported on the hub by two ball bearings, located axially by distance rings and circlip. The design is ready to push-on. The axial location of the clutch is made via a locking collar and set screw in the free shaft end.

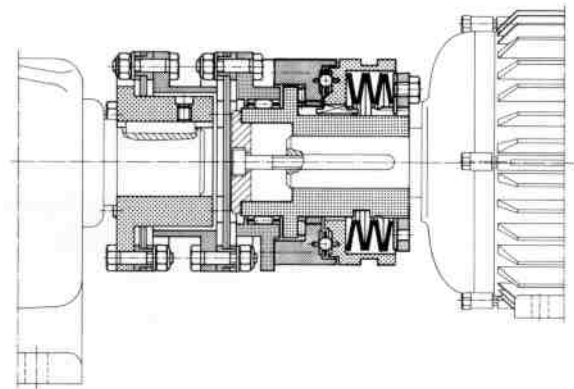

EAS[®] Type 436.600.8

Torsionally rigid flexible all-steel clutch-coupling for connecting two shafts, as used between motor and gear box. It compensates axial, radial and angular shaft misalignments. The axial attachment of the EAS[®]-clutch components is made via a locking collar and set screw in the free shaft end. The coupling hub is located by a set screw over the keyway.

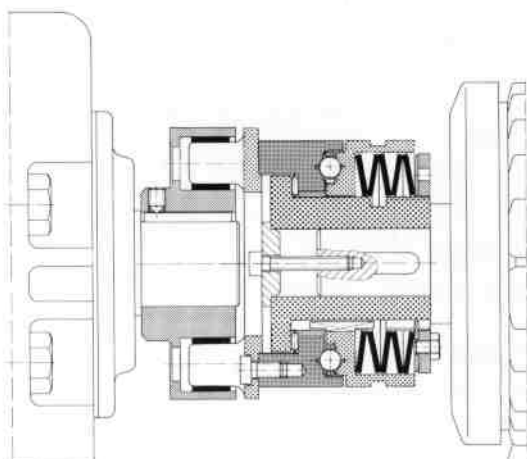

EAS[®] Type 437.600.0

Torsionally flexible clutch-coupling for connecting two shafts. This combination is shown between motor and gear box. The coupling is torsionally, flexible and allows for misalignment in all three phases. The flexible element is designed as plug coupling allowing easy assembly and disassembly. The axial location of the EAS[®]-clutch component is made via a locking collar and set screw in the free shaft end. The coupling hub is located by a set screw over the keyway.

- Potential free contact outputs
- Mechanical or contactless reading
- Enclosed designs
- Simple over point setting



Application

- Monitoring of mechanical movements and final positions.
- Control switch for electrical and mechanical sequences.
- In connection with EAS[®]-products:
In the event of an overload the axial disengaging movement of the control element of the EAS[®]-clutch is monitored fast and precisely.
The limit switch gives a signal to switch off the drive or for any other control function.

Designs

- | | |
|--|----------------------------------|
| - Aluminium housing | Type 055.000.5 |
| - Sea-water resistant version | Type 055.000.9 |
| - Flameproof limit switch | Type 055.000.8 |
| - Contactless limit switch
internal transmitter
external transmitter | Type 055.002.5
Type 055.001.5 |
| - Mechanical sensing
universal operation - IP 65 | Type 055.010.6 |

Limit switch Type 055.000.5 - mechanical contact

Aluminium housing

Dimensions

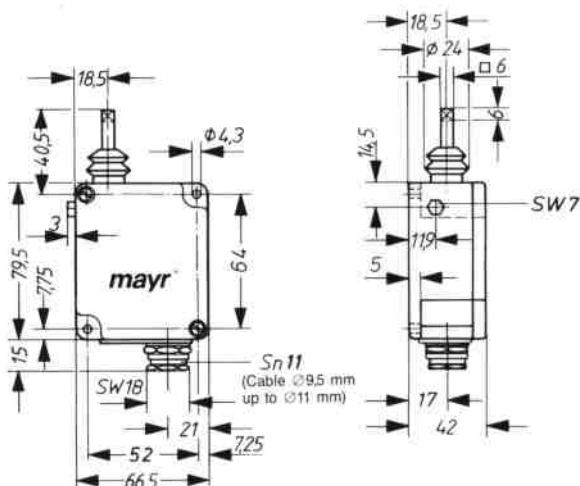

Wiring diagram

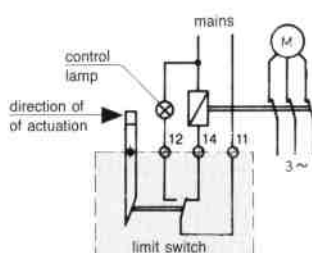

Design

The micro switch fitted into an aluminium housing is actuated by a control lever.
Operation is only possible in one direction. The housing is mounted via two fastening brackets arranged diagonally with cap screws M4.

Function

By actuating the control lever the pre-tensioned micro switch is unloaded.

Zero shift

Possible zero shift to right and left max. 5 mm each by the hexagon head cap screw arranged laterally, wrench width 7 mm.

Switch lead 0,5 mm

Switch lag 5 – 10 mm, depending on the zero shift.

Technical data

1 x change over contact potential free

Contact load	max. 250 VAC/15A
- resistive load -	max. 24 VDC/6A
	max. 60 VDC/1,5A
	max. 250 VDC/0,2A

Protection IP 54

Temperature range - 10° C bis +85° C

max. switching frequency 200 switchings/min.

Special Types (on request)

- Micro switch with 2 change over contacts
- Switch contacts, capable of bearing higher loads
- different switch lever lengths

Limit switch – proximity sensing

Type 055.002.5 (internal transmitter)
Type 055.001.5 (external transmitter)

Design

The electronic amplifier is fitted into a light metal case which can be attached via two diagonal fastening brackets; cap screws M4. The NAMUR transmitter attached in series is fitted directly to the case (Type 055.002.5) and remotely with a 2 m cable (Type 055.001.5). Operation is possible from all sides. Monitoring against breakage of the cable, if the supply voltage or NAMUR transmitter is interrupted.

Function

The transmitting relay is triggered during passing the sensor area of the NAMUR transmitter with a metallic control flag.

Undamped: Transmitting relay is energised
Contacts 1-2 closed
Contacts 2-3 opened

Damped: Transmitting relay is de-energised
Contacts 1-2 opened
Contacts 2-3 closed

Zero shift (only possible with the Type 055.002.5)

Possible zero shift to right and left 1 mm each, depending on the zero shift, via hexagon screw (7 mm A/F) on the long side of the limit switch.

Dimensions

Type 055.002.5

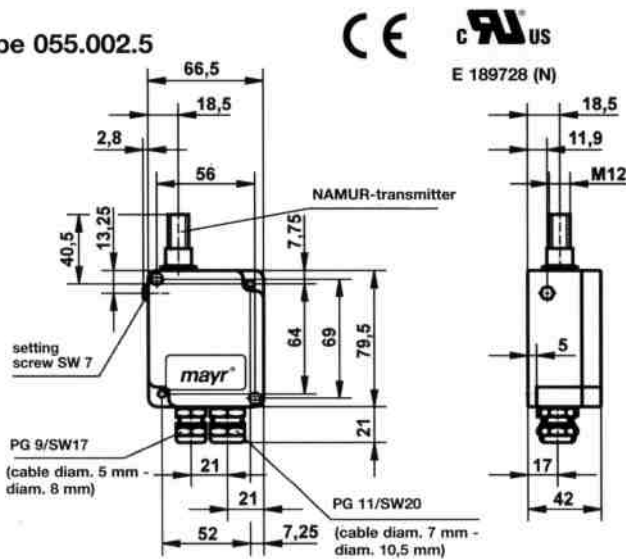

- internal NAMUR-transmitter to EN 50227

Type 055.001.5

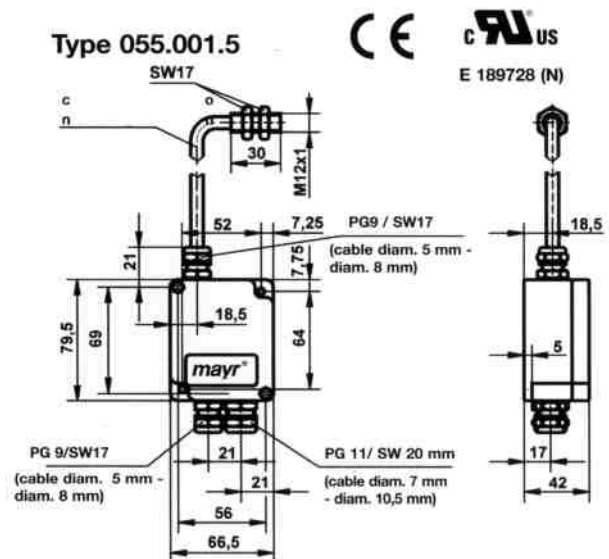

- external NAMUR-transmitter to EN 50227

Technical data

Supply voltage	230 VAC ± 10% , 50-60Hz 115 VAC ± 10% , 50-60Hz 24 VDC ± 5%
Input	1,5 VA
Transmitting relay	1 x change over contact potential free
Contact load - resistive load -	230 VAC / 5A
NAMUR transmitter	switching distance S_n max. 2 mm (flush fitting possible)
Temperature range	-10 °C up to + 60 °C
Protection	amplifier IP 54 NAMUR-transmitter IP 67 EN 50227
max. switching frequency	2 kHz

Special types (on request)

- other switching distances
- other cable lengths for the NAMUR transmitter

Wiring diagram

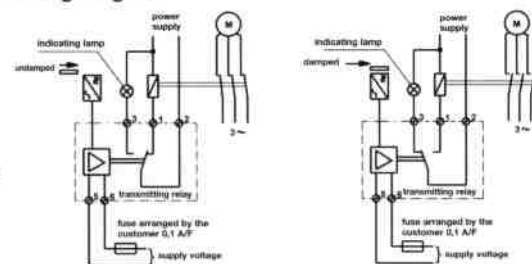

Important! Miniature fuse
The fuse -0,1 A/link of the limit switch is to be arranged by the customer and is to be provided for the line of the supply voltage.

Order example - proximity sensing

To be included when ordering, please state	Type	Connected voltage
Order number:	055. 00 .5	---

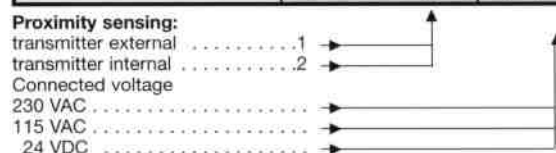

Example: Proximity limit switch with an external transmitter and a connected voltage of 230 VAC; order number 055.001.5 / 230 VAC.

Limit switch Type 055.010.6 – universal operation

Application

Monitoring of universal, mechanical movements and adjustments.
Suitable for clutches with a minimum 1,1 radial or 0,9 mm axial stroke.

Design

The double opener contact is fitted into a glass-fibre rod reinforced thermoplastic housing. It can be actuated via a metal rod from all directions. The limit switch is fastened via M5-cap screws.

Function

By actuating the metal rod the contacts 11–12 are opened.
(Forced separation)

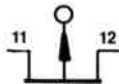

Fig. 1 diagram

Technical data

Contact	1xopener (Zb)
Contact-opening	after 0,1 mm pre-running with axial actuation after 0,2-0,4 mm pre-running with radial actuation
Contact load - resistive load -	contact distance > 1,25 mm = 250 VAC/2,5 A 24 VDC/1 A contact distance < 1,25 mm* = 24 VDC/1 A * min. contact distance 0,5 mm
Max. actuating travel of the metal rod	4 mm axial and radial
Mech. service life	1 x 10 ⁶ operations, unloaded
Switching frequency	max. 100/min.
Cable gland	PG11
Protection	IP65
Operating temperature	-30 °C up to +80 °C
Max. connection cross section	1,5 mm ²
Completely insulated:	Housing material is self-quenching, low flammability acc. to UL 94-VO, creep resistant

Standards

CE	
EN 60529	Protection
EN 60204	Security of machines -electrical outfit af machines-
EN 60947-1	Low voltage switch gears -general determinations-
EN 60947-5-1	Low voltage switch gears -control units and control elements-

Dimensions

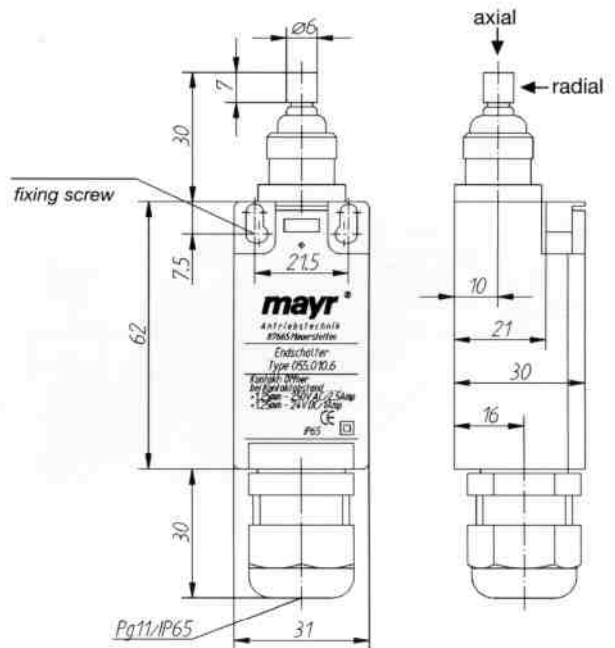

Fig. 2

Switching travel diagram

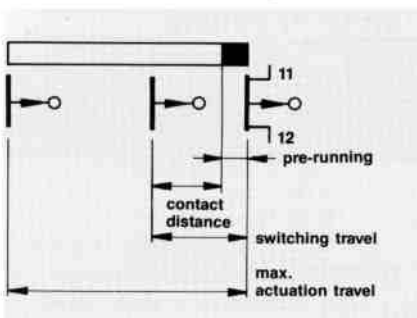

Fig. 4

Wiring diagram limit switch

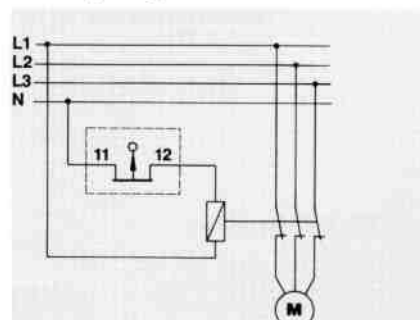
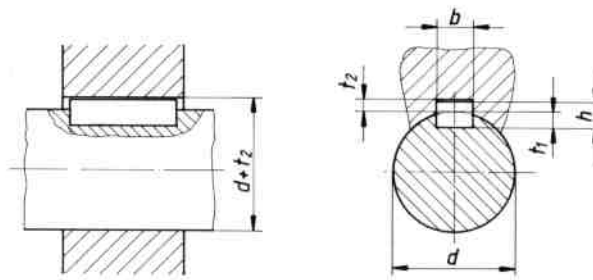

Fig. 5



Diameter d		according to DIN 6885 / 1				according to DIN 6885 / 3			
		Width b 1)	Depth h	Shaft keyway depth t ₁	Hub keyway depth d + t ₂	Width b 2)	Depth h	Shaft keyway depth t ₁	Hub keyway depth d + t ₂
above	to								
[mm]	[mm]	[mm]	[mm]	[mm]	[mm]	[mm]	[mm]	[mm]	[mm]
6	8	2	2	1,2	d + 1	2			
8	10	3	3	1,8	d + 1,4	3			
10	12	4	4	2,5	d + 1,8	4			
12	17	5	5	3	d + 2,3	5	3	1,9	d + 1,2
17	22	6	6	3,5	d + 2,8	6	4	2,5	d + 1,6
22	30	8	7	4	d + 3,3	8	5	3,1	d + 2,0
30	38	10	8	5	d + 3,3	10	6	3,7	d + 2,4
38	44	12	8	5	d + 3,3	12	6	3,9	d + 2,2
44	50	14	9	5,5	d + 3,8	14	6	4,0	d + 2,1
50	58	16	10	6	d + 4,3	16	7	4,7	d + 2,4
58	65	18	11	7	d + 4,4	18	7	4,8	d + 2,3
65	75	20	12	7,5	d + 4,9	20	8	5,4	d + 2,7
75	85	22	14	9	d + 5,4	22	9	6	d + 3,1
85	95	25	14	9	d + 5,4	25	9	6,2	d + 2,9
95	110	28	16	10	d + 6,4	28	10	6,9	d + 3,2
110	130	32	18	11	d + 7,4	32	11	7,6	d + 3,5
130	150	36	20	12	d + 8,4	36	12	8,3	d + 3,8
150	170	40	22	13	d + 9,4				
170	200	45	25	15	d + 10,4				
200	230	50	28	17	d + 11,4				
230	260	56	32	20	d + 12,4				
260	290	63	32	20	d + 12,4				
290	330	70	36	22	d + 14,4				
330	380	80	40	25	d + 15,4				
380	440	90	45	28	d + 17,4				
440	550	100	50	31	d + 19,5				

1) tolerance range of the hub keyway width b is JS 9
 2) tolerance range of the hub keyway width b is J 9

Bore diameter		Dimensions	
above	to		
[mm]	[mm]	[μm]	[μm]
6	10	+ 15	0
10	18	+ 18	0
18	30	+ 21	0
30	50	+ 25	0
50	80	+ 30	0
80	120	+ 35	0
120	180	+ 40	0

The EAS[®]-product programme offers in addition to the standard EAS[®]-clutches a comprehensive range of safety clutches for torque limitation together with the EAS[®]-axial overload protection units for straight lined force limitation.

Please ask for our detailed catalogues on the following products:

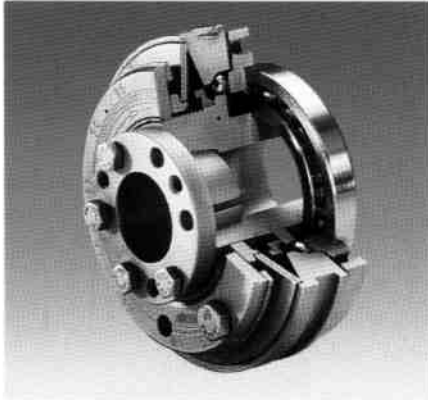

EAS[®]-NC clutches

They fulfill the specific requirements of high performance dynamic drives to an optimum degree. These positive patented permanently backlash free torque limiting clutches limit torque exactly to the pre-set value. The different constructional designs of both basic versions, ratchetting and synchronous clutches, cover all possible mounting variations.

For connecting two shafts, different backlashfree clutch/coupling combinations are used, which are ideal for modern, directly driven servo axes.

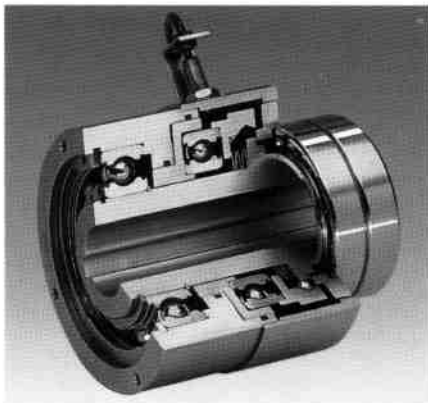

EAS[®]-Sp / EAS[®]-Sm / EAS[®]-Zr

Pneumatically and electromagnetically controlled torque limiting clutches with ON/OFF function: The control function is important when different torques should be limited during operation. The clutches accommodate exactly the transmittable torque to the production cycle via the pneumatic pressure or electrical voltage. The On/OFF function allows a remote control and the engaging or disengaging of drives. Control units designed for the clutch provide an optimal usage of the clutch facilities and performance.

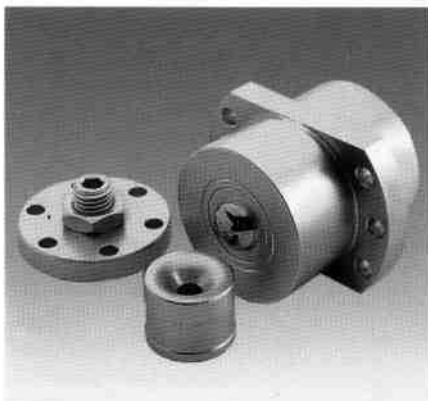

EAS[®]-Overload / EAS[®]-Element

Overload clutches based on the EAS[®]-elements transmit high torques up to 190 kNm. In case of an overload the clutches disengage and remain in a disengaged position allowing the drive masses with their accumulated energy to slow down freely.

The EAS[®]-elements themselves can be used for a suitable installation into consisting designs. They offer the possibility to suit special designs used by the customer. The size and number of elements and the pitch circle radius on which they are attached determine the value of the transmittable torque.



EAS[®]-axial

These overload safety devices for the protection of linearly moved masses limit the tensile and compressive forces to a corresponding pre-adjusted value. The force is transmitted backlash-free with high axial stiffness. In case of an overload the EAS[®]-axial disengages and interrupts the force transmission. High grade material, hardened functional elements and superior manufacturing precision guarantee the excellent repetitive accuracy and long service life. The adjustable release forces of the eight sizes are between 50 and 300 000 N. Each size is available in 12 different constructional designs.

Worldwide representation

Headquarters:

Chr. Mayr
GmbH + Co. KG
Eichenstraße 1
D-87665 Mauerstetten
Tel.: 49-83 41/8 04-241+242
Fax: 49-83 41/804 422
<http://www.mayr.de>

Great Britain:

Mayr Transmissions Ltd.
Valley Road
Business Park
GB-Keighley BD21 4LZ
West Yorkshire
Tel.: 0 15 35/66 39 00
Fax: 0 15 35/66 32 61

USA:

Mayr Corporation
4 North Street
USA-Waldwick
NJ 07463
Tel.: 2 01/4 45-72 10
Fax: 2 01/4 45-80 19
eMail: mayr@erols.com

Switzerland:

Mayr Kupplungen AG
Tobeläckerstrasse 11
CH-8212 Neuhausen
am Rheinfall
Tel.: 0 52/6 74 08 70
Fax: 0 52/6 74 08 75
eMail: info@mayr.ch

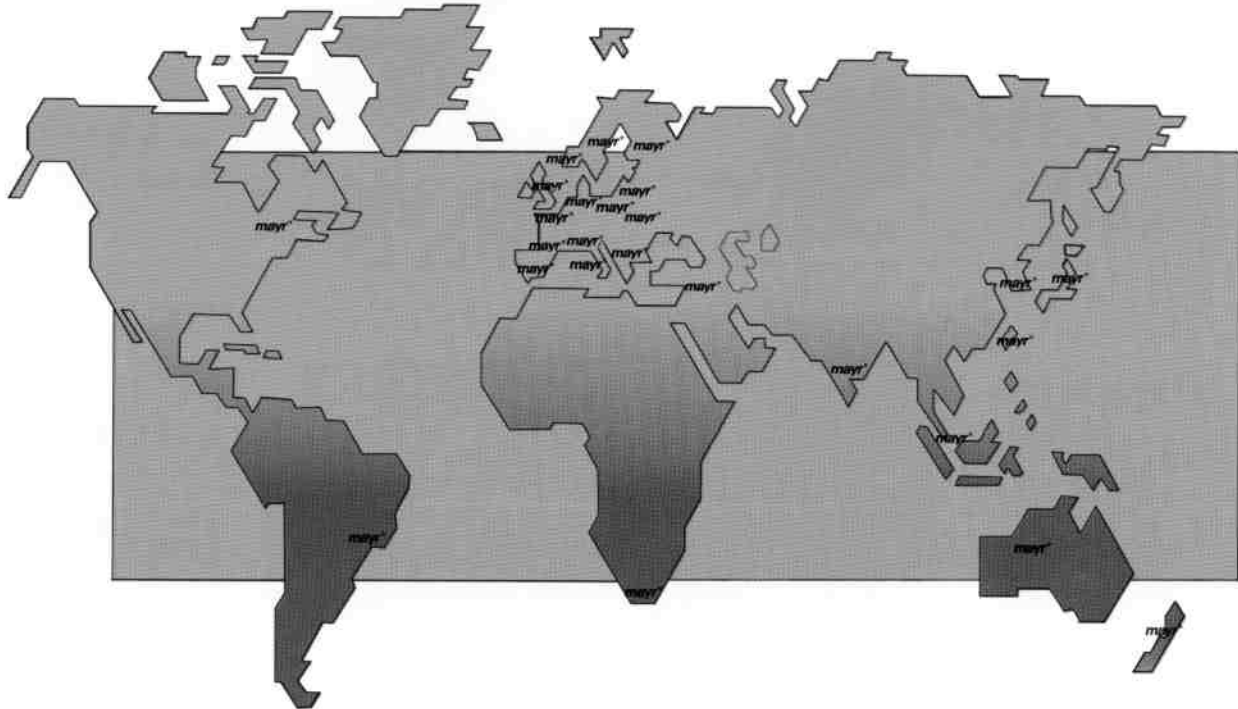

Italy:

Mayr Italia S.r.l.
Viale Veneto, 3
I-35020 Saonara (PD)
Tel.: 0 49/8 79 10 20
Fax: 0 49/8 79 10 22
eMail: mayrit@tin.it

France:

Mayr France S.A.
Z.A.L. du Minopole
BP 16
F-62160 Bully-Les-Mines
Tel.: 03/21.72.91.91
Fax: 03/21.29.71.77
eMail: mayrfrance@nordnet.fr

Singapore:

Mayr Transmission (S)
Pte. Ltd.
Blk 133
Jurong East Street 13
Unit 03-291
SGP-Singapore 600133 Asean
Tel.: 560 1230
Fax: 560 1000

Korea:

Mayr Korea
P. O. Box 23
Changwon, Kyungnam
Rep. of Korea
Tel.: 0551/2 62 40 24
Fax: 0551/2 62 40 25

Representatives in:

Australia
Austria
Benelux States
Brazil
Canada
Czech Republic
Denmark
Finland

Greece
Hongkong
Hungary
India
Indonesia
Israel
Japan
Malaysia

New Zealand
Norway
Philippines
Poland
Russia
Slovakia
Slovenia
South Africa

Spain
Sweden
Taiwan/ROC
Thailand
Turkey

* Note: In case you don't find your country here, our headquarters is always prepared to advise you the agency responsible for you.

Headquarters:

Chr. Mayr GmbH + Co. KG
Eichenstraße 1
D-87665 Mauerstetten
Telephone: +49 83 41/8 04-241+242
Telefax: +49 83 41/804 422
Germany
<http://www.mayr.de>
eMail: info@mayr.de

Delivery Programme

Overload protection

Prevents costly damage, repairs and downtimes;

EAS®-clutches
Ball detent torque limiting clutches.

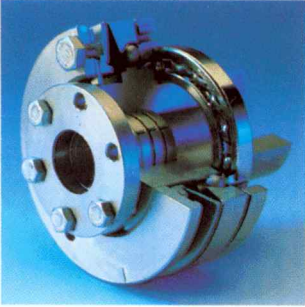

ROBA® slip hubs
Friction type torque limiters.

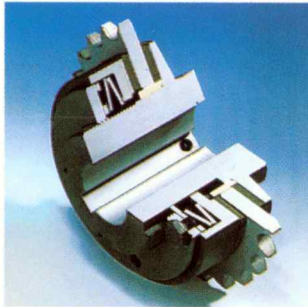

EAS®-axial
Overload protection for linearly moving components.

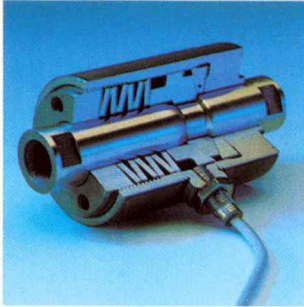

ROBA®-DS
torsionally rigid, flexible all steel couplings

Safe, backlash-free torque transmission even at high speeds; accommodates axial, radial and/or angular shaft misalignments.



Electromagnetic clutches and brakes



ROBA®-takt CBU
The alternative for switching – braking – cycling – positioning.



ROBA-stop® safety brakes
Electromagnetic release, spring applied brake for safe braking and exact positioning of rotating masses.



ROBATIC®-clutches and ROBA®-quick brakes

ROBA®-DX



Torsionally rigid steel bellows coupling for servo drives.

Switch gears and electrical accessories

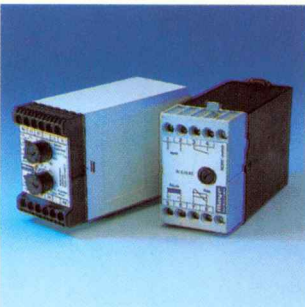

Since our engineers cannot be aware of all applications and control all the factors that may affect the function of our products, our warranty applies only to products manufactured by mayr®.

The user is solely responsible for making the final selection of the products and assuring that all performance, safety and warning requirements pertinent to the application are met. We are happy to offer our competent engineering assistance to work out a detailed recommendation for your specific requirements.

The specifications and availability of products described in this catalogue are subject to change at any time without notice.

ROBA®-ES backlash-free, flexible shaft coupling



Backlash-free torque transmission due to pre-stressed elastomeric element. Rigidity and damping behaviour can be varied via the hardness of this element.



Headquarters:
Chr. Mayr GmbH + Co. KG
Eichenstrasse 1
D-87665 Mauerstetten
Telephone: +49-8341/804-241+242
Telefax: +49-8341/804 422
Germany
<http://www.mayr.de>
eMail: info@mayr.de

Mayr Transmission Ltd.
Valley Road Business Park
GB-Keighley BD21 4LZ
West Yorkshire
Telephone: 0 15 35/66 39 00
Telefax: 0 15 35/66 32 61

Mayr Corporation
4 North Street
USA-Waldwick
NJ 07463
Telephone: 2 01/4 45- 72 10
Telefax: 2 01/4 45- 80 19
eMail: mayr@erols.com

mayr®
power
transmission