

SMW 050 - PERFORMANCE WITH 4-POLE MOTORS 1400 REVS. INPUT

TYPE	i=ratio	n2 r/min	Kw=P1	Nm=T2	f.s.	Possible types of motor connections	
SMW 050	7.5	186.7	0.75	33.3	2.0	80/71	B5/B14
	10	140.0	0.75	43.9	1.6	80/71	B5/B14
	15	93.3	0.75	62.6	1.2	80/71	B5/B14
	20	70.0	0.75	80	0.9	80/71	B5/B14
	25	56.0	0.55	70	1.0	80/71	B5/B14
	30	46.7	0.55	80	1.0	80/71	B5/B14
	40	35.0	0.37	67	1.1	80/71/63	B5/B14*
	50	28.0	0.37	78	0.9	71/63	B5/B14*
	60	23.3	0.37	87	0.8	71/63	B5/B14*
	80	17.5	0.25	70	0.9	71/63	B5/B14*
100	14.0	0.18	59	0.9	71/63	B5/B14*	

* 63 only B5

DIMENSIONS

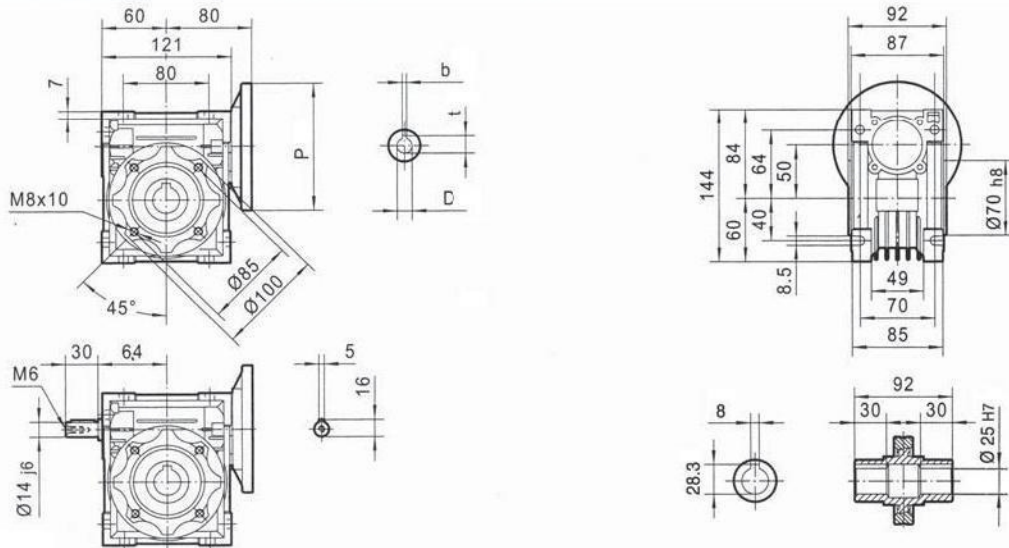

E

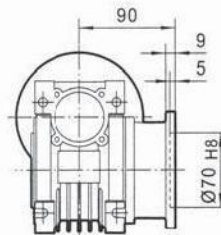
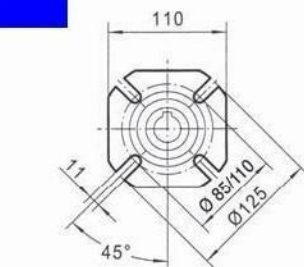

FA

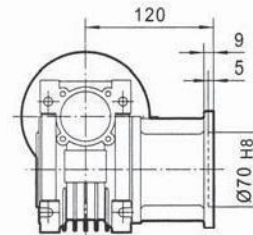

FB

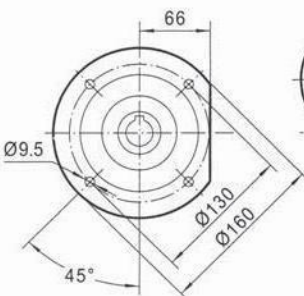

FC

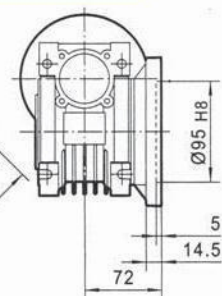
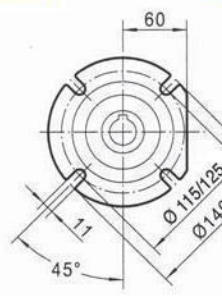
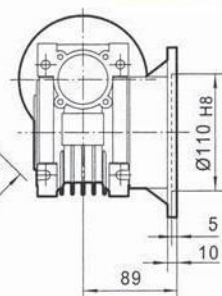

FD

PAM IEC	P	D _{E8}	b	t	PAM IEC	P	D _{E8}	b	t
80B5	200	19	6	21.8	80B14	120	19	6	21.8
71B5	160	14	5	16.3	71B14	105	14	5	16.3
63B5	140	11	4	12.8					

Weight 3.5 Kg excluding motor